

---

# Beekeeping in Tennessee

---



# Beekeeping in Tennessee

## Authors:

John A. Skinner  
Professor and UT Extension Apiculture Specialist  
The University of Tennessee

Michael Wilson and Geoffrey Duesterbeck  
UT Extension Assistants  
The University of Tennessee

Paul Rhoades  
Senior Lab Technician  
The University of Tennessee

James P. Parkman  
Adjunct Assistant Professor and IPM Coordinator  
The University of Tennessee

Michael D. Studer  
Apiarist  
Tennessee Department of Agriculture

Harry E. Williams  
Professor Emeritus (Deceased)  
The University of Tennessee

## Dedication: Mr. Harry E. Williams

The authors dedicate this publication in fondest memory of professor Harry Williams, who retired from the university in 1995 after serving as entomologist and apiculturist for 30 years. Harry received a bachelor's degree in biology from Middle Tennessee State University, followed by a master's degree in entomology from the University of Tennessee. He acquired much of his extensive training in entomology while doing the job he loved. Harry's training in beekeeping began one day when he was informed that he was the new apiculturist. After determining what that word meant, he studied hard and learned from knowledgeable beekeepers including Leslie Little, Charles Pless, Carl Johanson, Roger Morse and many others.

The most important attribute of Harry Williams was not based on academic pursuits including publications, knowledge or experience. His main attribute was that he simply cared deeply about people and helped them in every way he could. He assisted numerous beekeepers in Tennessee and throughout the Southeast to better understand how to care for their bees, from the beginner to the experienced person. Harry would appreciate this gesture and we are pleased to dedicate this publication in his memory.

## Acknowledgements:

Aurora Canaday for two photographs in Basic Anatomy: bee ingesting honey and three bees with pollen.

Laura Bryant for line drawing of ideal apiary.

Ken Lorenzen and Robin Thorp for several bee anatomy photographs.

To many Tennessee beekeepers who improved our knowledge, encouraged our efforts and were patient with the long time required to bring this publication to completion.

# Table of Contents

<b>Getting Started in Beekeeping</b> .....	5
Why Beekeeping? .....	5
Is Beekeeping for You? .....	5
What Is Beekeeping All About? .....	5
<b>Many Sources of Beekeeping Information Are Available</b> .....	5
Beekeeping Literature .....	5
Beekeeping Information on the Web .....	5
Beekeeping Organizations .....	6
Tennessee Beekeeping Associations .....	6
Educational Courses .....	6
University of Tennessee Master Beekeeper Program .....	7
Program Availability .....	7
Finding a Beekeeping Mentor .....	7
<b>Beginning Beekeeping Basics</b> .....	8
<b>Honeybee Stings</b> .....	8
<b>Beekeeping Regulations in Tennessee</b> .....	8
<b>Locating an Apiary</b> .....	8
Essential elements of an ideal apiary .....	8
<b>Bee Biology and Behavior</b> .....	9
<b>Basic Anatomy</b> .....	9
<b>The Honeybee Colony</b> .....	10
The Queen Bee .....	10
Bee Development .....	11
The Drone Bee .....	11
The Worker Bee .....	12
<b>The Colony as a Super-Organism</b> .....	13
Pheromones .....	13
<b>Races of Bees</b> .....	13
The Italian Honeybee .....	14
The Carniolan Honeybee .....	14
The Caucasian Honeybee .....	15
Italian Cordovan Honeybees .....	15
Breeding Lines or Strains .....	15
Colony Performance Standards .....	16
<b>Beekeeping Protective Gear</b> .....	16
<b>Hardware and Tools</b> .....	18
<b>Wooden Equipment</b> .....	19
Bee Space Is Important .....	19
Parts of a Standard Hive .....	19
Area for Brood Chamber and Supers .....	19
<b>Working with a Honeybee Colony</b> .....	23
<b>Inspecting a Colony</b> .....	23
<b>Starting Your Colony</b> .....	25
<b>Installing a Package of Honeybees</b> .....	25
Receiving a Package .....	26
Installation .....	26
<b>Other Methods of Bee Installation</b> .....	27
Starting by Collecting a Swarm .....	27
Preparing for a "Swarm Call" .....	28
Questions to Ask about Swarms: .....	28
How to Collect a Swarm .....	28
Splitting or Dividing a Colony .....	29

When Should a Colony Be Divided? .....	29
To Divide a Colony With Queen Cells .....	29
To Divide a Colony and Produce a Queen from Eggs .....	30
Dividing a Colony and Requeening with Purchased Queens.....	30
<b>Queen Marking</b> .....	31
How to Mark a Queen .....	31
<b>Requeening</b> .....	31
Why Requeen?.....	31
Queen Introduction.....	32
Installing a Queen in a Shipping Cage.....	33
Installing a Queen Using Press-in Cages.....	34
<b>Moving a Colony</b> .....	34
<b>To Move a Colony a Short Distance</b> .....	34
Secure the Colony Before Moving.....	34
Ventilate the Bees for the Move.....	35
<b>When to Move a Colony</b> .....	35
<b>Removing Surplus Honey</b> .....	35
<b>Methods to Remove Bees from Honey Supers</b> .....	36
Bee Repellants .....	36
Air Blowers .....	36
Bee Escapes .....	36
<b>If You Find Brood in Honey Supers</b> .....	36
<b>Avoid Robbing</b> .....	37
<b>Overwintering a Honeybee Colony</b> .....	37
Prepare the Colony.....	37
Provide Adequate Honey for Survival .....	37
Minimize Inspections in Cold Weather.....	37
Ventilate If Needed.....	37
Reduce Air Flow If Needed .....	37
<b>Pests of Honeybees</b> .....	37
<b>An ounce of prevention is worth a pound of cure.</b> .....	37
Culling comb .....	37
Monitoring for Disease.....	38
<b>Tracheal mite, Acarapis woodi</b> .....	38
Biology .....	38
Symptoms.....	38
<b>Varroa mites, Varroa destructor</b> .....	39
Economic Damage .....	39
Biology .....	39
Detection.....	40
Sensitivity of Method.....	42
Treatments.....	42
<b>Nosema</b> .....	44
Diagnosis.....	45
<b>The Small Hive Beetle</b> .....	45
<b>American Foulbrood</b> .....	46
<b>European Foulbrood</b> .....	46
Causative agent.....	47
Life cycle of European foulbrood.....	48
Symptoms of European foulbrood .....	48
Control .....	48
<b>Seasonal Management</b> .....	49
Winter Season .....	49
Spring Season .....	49
Summer Season.....	50
Fall Season.....	51

## Getting Started in Beekeeping

### Why Beekeeping?

Most people realize that beekeeping is important to worldwide agricultural production, because bees pollinate fruits and vegetables valued in billions of dollars. Without the honeybee, our food supply could be in serious jeopardy. The economic value of honey, wax and other hive products is continually increasing as we find new uses for bee-related products. People of either sex or any age can keep bees almost anywhere. When asked why they become beekeepers, people's responses are variable, including "to pollinate my garden," "to make honey to sell," "to teach my children something useful," "to put honey on my biscuits," "as therapy," to understand "what makes bees tick," because they thought it would be fun and "because I just like foolin' with 'em."

### Is Beekeeping for You?

There are many factors to consider before becoming a beekeeper and setting up your own honeybee colonies. This section contains information on the more important ones and may help you decide if beekeeping is right for you.

### What Is Beekeeping All About?

The first step in becoming a beekeeper is deciding if you actually want to be one. It would be a shame to commit a lot of time, effort and money in setting up a few bee colonies only to discover that you really don't enjoy beekeeping. There are several good ways to discover what's in store for you as a beekeeper. These methods include reading some of the vast amount of literature on the subject; attending local, regional or state beekeeping association meetings; attending beekeeping educational classes; visiting beekeeping websites; and establishing a relationship with an experienced beekeeper.

## Many Sources of Beekeeping Information Are Available

### Beekeeping Literature

Many good textbooks on beekeeping are available, including several suited for beginners. Although they vary in style and content, these books will provide adequate introductory information for any novice. Because of the differences in subject content, you may want to read at least two of these books.

In the U.S., there are two major monthly periodicals devoted to beekeeping: The American Bee Journal and Bee Culture. These periodicals contain a variety of information, from articles of popular interest to those reporting research results from beekeeping scientists. Reading them is a good way to find out about current beekeeping trends and issues.

University of Tennessee Extension has several beekeeping publications. They are available from your county Extension office and also can be downloaded and printed from the UT Beekeeping Web page at <http://bees.tennessee.edu/pubs.htm>.

Catalogs of beekeeping product suppliers may also provide useful information to the would-be and beginning beekeeper. You can familiarize yourself with the variety of available equipment and estimate the financial costs associated with becoming a beekeeper and maintaining bee colonies.

### Beekeeping Information on the Web

The UT Beekeeping website (<http://bees.tennessee.edu>) has a variety of useful information as well as links to other helpful websites. There, you'll be able to learn about goings on at the UT bee lab, download publications pertaining to beekeeping techniques, and find information on current honeybee disease and pest problems in Tennessee.

A link for the Tennessee state apiarist is also included, which allows you to register your bees and read the state apiary laws.

The association lists will allow you to find a local association in your area, the Tennessee Beekeeping Association and other state associations, along with national and international associations. These are good sources of information if you are interested in joining an organized group or just interested in talking to other beekeepers in your area.

## **eXtension.org**

The UT beekeeping website also links to eXtension.org, which links researchers and extension personnel from around the nation to share information on honeybee health and bee keeping practices. It is an excellent source for up-to-date information of beekeeping techniques and bee health.

There are many hyperlinks embedded through the electronic version of this document linking to eXtension pages that provide more information on those topics.

## **Beekeeping Organizations**

### **Tennessee Beekeeping Associations**

Tennessee has one state beekeeping association, the Tennessee Beekeeper's Association. The objectives of the TBA include the promotion of modern, scientific beekeeping throughout Tennessee, encouraging youth in the art of beekeeping, and informing the public of the importance of the honeybee. The organization has a large membership throughout Tennessee. Its board of directors includes representatives from 35 local associations (as of 2012). They encourage mentoring for youth and for new beekeepers; support the 4-H program; publish an award-winning, bimonthly newsletter; and enthusiastically host meetings where speakers from all over the country are invited to share new discoveries. Their meetings are very well organized and always have a wonderful balance of educational subjects and "just plain fun." Check <http://www.tnbeekeepers.org>, to learn all about the organization.

As of 2012, 35 beekeeping associations exist throughout Tennessee. They usually meet monthly and dues are reasonable. Many of these groups host short courses about beekeeping that are very worthwhile to the new beekeeper. If your county has no association, you may consider joining the association nearest you.

Regional associations are also available. The Eastern Apicultural Society (<http://easternapiculture.org>) serves beekeepers throughout the eastern United States. The society's annual meeting is held in the summer at different locations throughout the eastern U.S. The Heartland Apicultural Society (<http://www.heartlandbees.com>) serves states farther north, from Tennessee and Kentucky to Ohio, Indiana and Illinois.

National organizations also exist, such as the American Beekeeping Federation and the American Honey Producers Association. You may want to get a few years of beekeeping experience before joining a national organization. Another national source of information is the National Honey Board, which has an attractive and highly informative website.

## **National and International Beekeeping Organizations**

Regional and national Beekeeping organizations are a good source of general information as well as a good way to keep up with current events and trends in beekeeping. They also provide networking opportunities in the form of conferences and message boards. These organizations cater to beekeepers of different scale and style.

Mid-Atlantic Apicultural Research and Extension Consortium (MAAREC)  
<http://agdev.anr.udel.edu/maarec>

American Society of Professional Apiculturists  
<http://aapa.cyberbee.net>

American Beekeeping Federation  
<http://www.abfnet.org>

American Honey Producers Association  
<http://www.americanhoneyproducers.org>

Eastern Apicultural Society (EAS)  
<http://easternapiculture.org>

Heartland Apicultural Society (HAS)  
<http://www.heartlandbees.com>

## **Educational Courses**

Many beekeeping associations, including county associations, conduct educational "short-courses" or workshops on an annual or biannual basis. Many of the presentations made at TBA meetings are educational in nature. A portion of the annual EAS meeting consists of intensive training sessions, with some of the classes designed for the beginning beekeeper. University of Tennessee Extension offers a beekeeping educational program that educates at several levels.



Figure 1. Beemaster classroom instruction.



Figure 2. Beemaster field training.

## University of Tennessee Master Beekeeper Program

The Tennessee Beemaster Program is a training program developed to improve the knowledge of Tennessee beekeepers. The program has improved Tennessee's beekeeping industry and public relations concerning beekeeping, and has benefitted agriculture in the state. When asked to evaluate the program, participants recommended the basic level class for "beeginners" and for experienced beekeepers in need of a refresher.

The program is organized into Basic and Advanced levels.

**Basic** — This entry-level program requires no previous training to enroll. There is no mandatory "years of beekeeping" requirement for this level. This level emphasizes a general understanding of topics that will serve as a foundation to expand and build upon in the advanced level.

Ten lectures are presented, covering such subjects as sources of beekeeping information for the "beeginner," basic bee biology and behavior, seasonal management, bee diseases and pests, and processing of honey and wax. This book is provided as a general text for this level. The final class includes a trip to an apiary to gain some hands-on experience.

**Advanced Level** — The purpose of the Advanced Master Beekeeper Program is to give experienced beekeepers the information and training they need to be able to teach other beekeepers. To complete this advanced program participants must participate in an Advanced Master Beekeeper Workshop. The training uses a set of lectures and hands-on experiences and workshops to provide factual and applied information about bees and beekeeping. This level is designed to teach the experienced beekeeper about queen rearing, making hive products, marketing, management, and how to recognize bee diseases and pests, including detection, diagnosis and treatments. Diseases covered include American and European foulbrood, nosema, sacbrood, chalkbrood and bee paralysis. Pests to be studied include tracheal and varroa mites, small hive beetles, wax moths and the Africanized bee.

The training includes demonstrations, slides, videos and laboratory preparations and hands-on training sessions in the apiary.

## Program Availability

For more information about the program and class offerings, please consult <http://bees.tennessee.edu>.

## Finding a Beekeeping Mentor

A mentor is an experienced beekeeper who can guide you by answering your questions and can show you how to do procedures that you may not understand without experience. You can find a mentor

through an association, Extension office or state apiculturist. Although literature can provide a plethora of beekeeping advice, reading is no substitute for actually working with the bees.

## Beginning Beekeeping Basics

- Start small. Two colonies is an ideal number for an inexperienced person to keep for one or two years.
- Expand as your experience and confidence grow.
- Start right. Avoid discouraging mistakes at the very beginning by thorough preparation. Read, read, read and ask questions of beekeepers and Extension staff.
- Buy new equipment. The experience of assembling new hives is very informative for the inexperienced beginner.
- Plan ahead. Order your bees, hives and tools in the fall. The hives and tools should be delivered in time to be assembled before your bees arrive the following April.
- Be ready. When you obtain packaged bees or a nucleus colony, your hives should be assembled and located on the site selected for your apiary.

## Honeybee Stings

The would-be beekeeper should realize that, as a beekeeper, he or she will occasionally be stung. Stinging is the bees' way of defending their colony. Honeybee stings are not a major medical problem for more than 99 percent of our population. Most people do not experience anything other than localized swelling, redness and pain as the result of being stung. Being stung could be considered a learning experience. It's often an indication that the beekeeper is doing something wrong. Most stings can be avoided by using protective equipment and acquiring experience in gentle handling of frames containing live bees.

## Beekeeping Regulations in Tennessee

- All honeybee colonies are required to be registered with the state apiarist of the Tennessee Department of Agriculture, according to the Tennessee Apiary Act of 1995. For more information, visit <http://www.tn.gov/agriculture/regulatory/apiaryregistration.shtml>.

[tn.gov/agriculture/regulatory/apiaryregistration.shtml](http://www.tn.gov/agriculture/regulatory/apiaryregistration.shtml). (State Apiarist in 2012: Mike Studer at 615-837-5342 or email at [Mike.Studer@tn.gov](mailto:Mike.Studer@tn.gov).)

- All equipment or colonies purchased from another beekeeper must be inspected by a bee inspector from their state of origin and determined to be free of regulated diseases and otherwise adhere to applicable regulations.
- All hive equipment should have, movable frames, as required by the Tennessee Apiary Act of 1995 (<http://russianbreeder.net/beelaw1.html>).

## Locating an Apiary

A site where honeybee colonies are located is called either an apiary or bee yard. You should plan the location of the apiary before obtaining colonies. An ideal location should include as many essential elements as possible for maximum performance by your colonies.

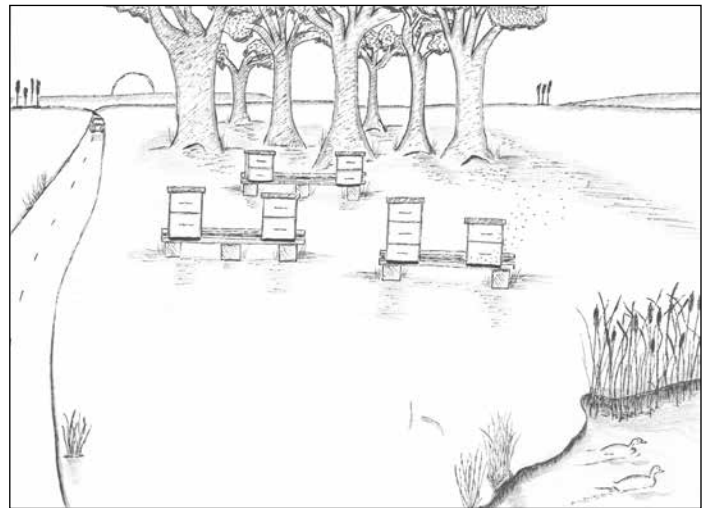

Figure 3. The ideal apiary.

### Essential elements of an ideal apiary include:

- Abundant sources of nectar and pollen located within a mile of the apiary. A variety of plants will increase the availability of nectar and pollen year-round. Bees need pollen for brood rearing and surplus honey made from nectar for successful overwintering.
- A good source of clean water should be available within one-quarter of a mile. If clean fresh water is not available, a container of water can be provided. Be sure to include a landing support surface to allow the bees to stand on without drowning. Wood



blocks, cork blocks, rocks, gravel or burlap cloth can be used in the container to provide dry support.

- Good air circulation with no stagnant air pockets. A location with a gentle slope is suitable, but avoid placing colonies in low areas with poor air circulation.
- Good water drainage in an area above flood level. Flooding quickly kills colonies and can literally float them away.
- Provide morning sun and afternoon shade for colonies, if possible. Eastern entrance exposure for morning sun is great. Be careful not to place colonies in locations that are shaded most of the time. Total sun exposure would be better for colonies than total shade.
- Protection from direct winds, especially in winter. Trees or shrubs are good wind breaks.
- Orient multiple colonies in a “U” or “S” shape rather than in a straight line. When colonies are placed in a straight line, bees tend to drift to colonies at the ends of the line, which weakens colonies in the middle.
- Ready access — The apiary must be easy to get to with a vehicle. Bee colonies are heavy. You do not want to carry heavy equipment up hills, through mud holes or across drainage ditches. Avoid locked gates unless you have a key. The apiary should be near a hard-surface road. It will be necessary to visit your apiary in all kinds of weather. Although the apiary should be near a road, it is best if it is not easily seen from the road, especially if the road is open to the public. Vandalism and theft may occur.
- Good neighbor beekeeping: keep your neighbors happy. A present of a jar of honey may help. Reduce interactions between your bees and your neighbors as well as with pets or livestock. Locate your bee yard where human interactions are minimal. Don't locate your bees where humans can walk into the bees' flight path to and from the hive. Fences of wood or shrubbery can be used to direct flight up and away. Provide water sources closer than a neighbor's water source. Your bees may be attracted to a neighbor's swimming pool or a leaky spigot. Some people are frightened of bees and no amount of education will allay their fears.

## Bee Biology and Behavior

### Basic Anatomy

Like all segmented insects, honeybees have three major body regions: a head, a thorax and an abdomen.

The primary function of the head is to receive sensory stimulation via eyes, antennae and mouthparts. The thorax functions in locomotion with legs and wings. The abdomen functions in reproduction, digestion and defense.

On the head are five eyes (three simple and two compound) and two sensory antennae that receive stimuli for hearing, taste, smell and touch. The mouthparts include the tongue (proboscis) used for lapping and sucking fluids and the jaws (mandibles) used for shaping beeswax and other solids such as pollen.

The abdomen is the largest region. It also contains important structures and organs. Like the thorax, there are spiracles on the sides of the abdomen. Spiracles are openings that lead to the trachea and respiratory system of insects. The stinger is found on the tip of the abdomen of female bees. Worker bees' abdomens contain wax-secreting glands and the scent gland. The queen's abdomen

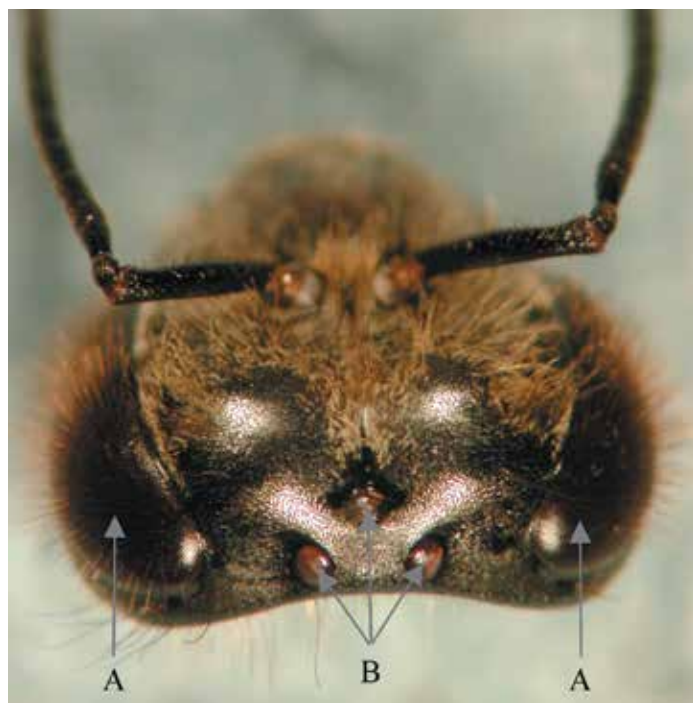

Figure 4. Honeybee eyes. A – Two compound eyes. B – Three simple eyes.



Figure 5. Sensory structures on worker honey bee antennae.

contains ovaries that produce eggs, a storage organ for drone (male bee) sperm called the spermatheca, pheromone-producing glands and a stinger. The drone's abdomen contains reproductive organs but no stinger or wax glands.

### The Honeybee Colony

Honeybees are social insects. They live in colonies that can grow to more than 60,000 individual bees. Each colony may be considered a model of social order in which every member has its appointed task. A colony consists of the queen, who fertilizes and lays the eggs; the drones, whose only function is the fertilization of a virgin queen; and the workers, whose lives are devoted to the survival and welfare of the colony. Let's take a closer look at each of these members of a bee colony — their appearance, their development patterns and their functions in the hive.

### The Queen Bee

The queen is the most important member of the hive. She is reared in a special cell, shaped like a peanut, which is usually suspended vertically from the lower part of the comb. Queen cells are larger than regular cells. The queen develops from a fertilized egg (as do the workers), but she is fed throughout her larval life with royal jelly, a glandular food secreted by young workers known as nurse bees. She is given ample feedings of this jelly, which causes her to develop differently than workers and more quickly than either workers or drones.

Normally, the egg-laying queen is much longer than the workers or the drones. Because she has a longer abdomen, her wings appear shorter and her thorax slightly larger than the same parts on workers' bodies. Her thorax, however, is smaller than that of a drone. She does not have pollen baskets or wax glands. Her sting is stouter than the workers', has



Figure 6. Honeybee feeding.



Figure 7. Three bees with pollen in their "pollen" baskets on hind legs. Note the bee on the left with orange pollen on its head.

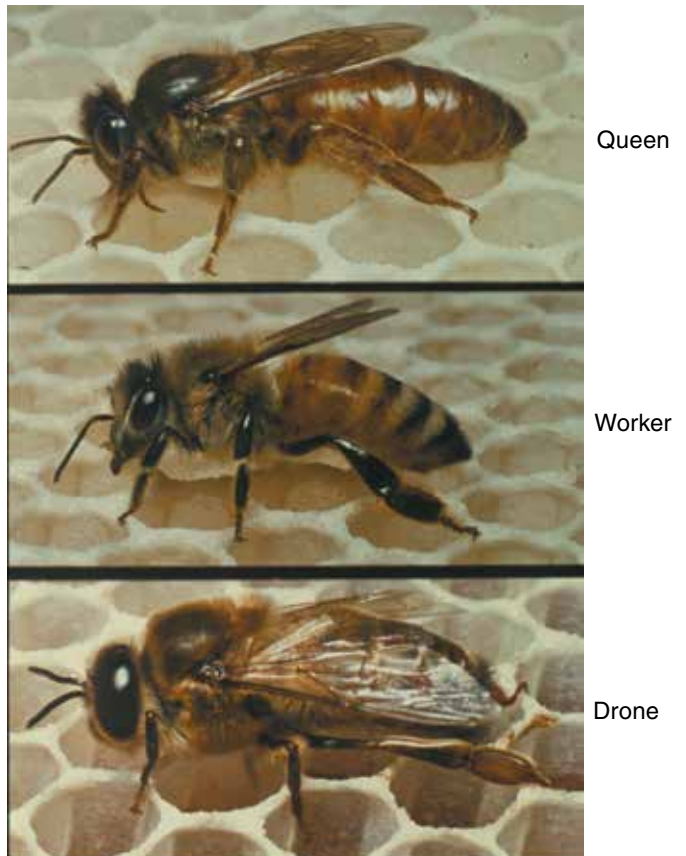

Figure 8.



Figure 9. Queen cell.

fewer and shorter barbs and is curved. She rarely uses her sting except when she emerges from her cell and encounters other queens in the colony. In this event, the young queens battle until only one remains.

The queen bee has fully developed ovaries and is the only bee in a colony that is capable of fertilizing the eggs she lays. Five to 10 days after emerging from her cell, the queen takes one or more flights and mates with drones, normally 12-15, in the air. During these mating flights, she attempts to mate with enough drones to provide her with a sufficient quantity of sperm for her lifetime. The sperm she receives from the drones is stored within the spermatheca. Once her spermatheca is full of sperm, she will never mate again.

**The queen is a prolific egg layer.** At first, the queen lays only a few hundred eggs each day. Later in the spring or early summer, she can lay up to 2,000 eggs or more in a single day. She deposits the eggs in cells in a circular pattern, radiating out from the center of the brood frame. Worker bees reach maturity in 21 days. As workers mature, the cells are cleaned and the queen deposits new eggs. Drone eggs are laid early enough in the spring and summer to provide adult drones by the time a colony normally would swarm. The queen can lay worker or drone eggs at will. But when there is a shortage of nectar and/or pollen, the egg-laying is slowed down or even stopped.

## **Bee Development**

The following table shows the number of days required for the development of the worker, the drone and the queen. These periods will vary with temperature of the brood nest, but rarely by more than 24 hours. See also the diagram on page 12 with details of the life history of the worker bee.

**Fertilized eggs develop into females.** The queen fertilizes the eggs that will develop into worker bees as she deposits them. Consequently, worker bees have characteristics of both the queen and the drones with which she mated. Unfertilized eggs, which she deposits in the larger cells, become drones. Drones bear only the characteristics of the queen herself. It can be said a drone honeybee has a grandfather but no father.

The queen can live as long as eight to 10 years, however this is unlikely. In production colonies, unless replaced by the beekeeper, queens will normally be replaced (superseded) after their second or third year. As a queen ages, she gradually uses her supply of sperm and may lay an increasing number of drone eggs. If she fails to mate, all of her eggs will be unfertilized, hence males, and she is then known as a drone-layer.

## **The Drone Bee**

The drones are the male bees in the colony. Their sole function is reproduction. Drones who succeed in mating with a queen during her nuptial flight perish in the act. Drones are larger and heavier than the workers, but not as long as the queen. It is easy to identify a drone by its large compound eyes that come together at the top of the head.

Usually several hundred to several thousand drones are present in a colony during the active foraging season. The young drones are fed by the workers; the older drones feed themselves honey



Figure 10. Egg-laying queen in center, surrounded by workers.

directly from the storage cells. During the season, should the food supply diminish for any reason, workers waste no time in ejecting drones from the colony. After the first heavy frosts in the fall reduce the supply of nectar and pollen, the colony prepares for winter by driving the drones from the hive. They soon starve to death.

### The Worker Bee

Worker bees perform all the labor of the hive. Although they are females, they lack the fully developed reproductive organs of the queen. Normally they do not lay eggs, although if the colony is without a queen, or a queen cell, a few workers may begin to lay drone eggs. The eggs they lay are drones because the workers are unmated. A colony in such a condition is termed a laying worker colony. A laying worker colony may attempt to raise a new queen from their drone eggs. These will not develop into queens and can give the beekeeper a false impression that a new queen is developing.

**Worker “Job Description” and Behavior.** The lives of the worker bees fall roughly into two periods (see diagram on page 12). During the first period of approximately three weeks, they are called hive or house bees. On emerging from their cells, they groom themselves and engorge on honey and pollen from the storage cells. Their first three days are spent cleaning out brood cells. Thereafter, they clean the hive, feed the older larvae and then the younger larvae, take orientation flights, evaporate nectar, build comb, feed the queen and the drones, keep an even temperature in the brood nest, and guard the entrance to the hive. These differences in responsibilities based on worker age are known as a division of labor. But, depending on specific circumstances, it can be very flexible. The last half of a worker bee’s adult life is devoted to foraging duties outside the hive. Four necessary items collected outside the hive are pollen, nectar, water and propolis (bee glue).

**Early Duties Include Wax Production and Comb Building.** Bees produce the beeswax used in the construction of their combs from the four pair of wax glands located on the underside of the abdomen. These glands are most highly developed and active in bees 10-18 days old. The wax appears in small, irregular oval flakes or scales that project between the overlapped portions of the last four abdominal segments. Wax can be secreted only at relatively high temperatures and after a large intake of honey or nectar.

**Older Bees Are Field Bees: Scouts or Foragers (Collectors).** During the active season, the lifetime of a worker is five to six weeks. Overwintering worker bees may, however, live for four to six months. Whatever their life span, worker bees usually confine themselves to one task at a time, working without pause. If they are field bees, they may be scouts or collectors. Scouts look for sources of nectar and pollen. Once suitable sources are located, the scouts recruit additional foragers.

Nectar collectors, pollen foragers, water gatherers or propolis gatherers work so single-mindedly at their jobs, they will not stop even to collect honey placed before them.

During the day, one may see hundreds of spent workers, wings ragged, returning wearily to the hive. Worker bees are aptly named as they literally work themselves to death. Death occurs following approximately 500 miles of flight.

**Propolis Collection.** Propolis, also known as bee glue, is a resinous, reddish-brown substance gathered by the bees from gum found on trees and buds. It is used to close small crevices in the hive. Propolis is very sticky in warm weather and brittle in cold weather.

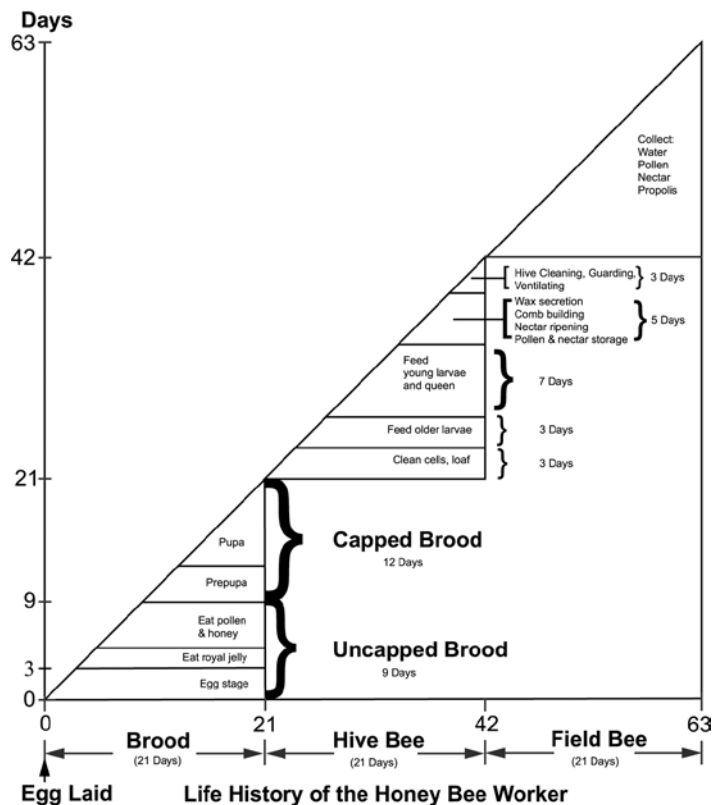

Figure 11. Worker bee life history.

## The Colony as a Super-Organism

Highly social insects occupy a special place in the animal world. The teamwork of social behavior produces many benefits for honeybees just as it does for humans. In fact, through cooperation, honeybees developed a number of traits one typically associates with mammals or even human societies. For instance, honeybee immature stages are fed glandular secretions produced by adults, like mammals. Also similar to mammals, honeybee colonies are kept at a constant temperature insofar as the health of the colony permits it. For humans this temperature is 36 degrees C; honeybees keep their brood nest at 35 degrees C. Additionally, honeybee colonies have traits associated with human societies like banding together for mutual defense and storage of food resources for times of dearth. Like human societies, honeybees have methods of communicating facts relating to defense and resource acquisition. Their methods of communication are, of course, different.

## Pheromones

Pheromones are (often volatile) chemicals secreted by animals that influence the behavior or development of other members of the same species. Pheromones are frequently emitted by female insects to attract males for mating, often over several kilometers. In social insects the use of pheromones becomes more complex.

### Alarm Pheromone

This suite of pheromones is emitted when bees sting or otherwise feel threatened. To humans, alarm pheromones smell like bananas. These pheromones mark the site of a sting, making it a target. Alarm pheromones are also released by guard bees when they sense a disturbance. This induces other bees into behaving defensively. Application of smoke before tampering with a colony may interrupt detection of alarm pheromones, making the colony more docile for inspection.

### Brood recognition pheromone

Immature honeybees (both larvae and pupae) emit this compound to inhibit ovarian development in worker honeybees and prevent them from laying eggs. Brood recognition pheromone also mediates the ratio of nurse bees to foragers ensuring there are enough nurse bees to care for the brood.

## Other uses of pheromones by bees:

- Drones produce pheromones that attract other drones to produce drone congregation areas for mating.
- Pheromones help workers differentiate between eggs laid by a queen and those laid by workers.
- A pheromone is released by field bees (older workers) that slows the development of nurse bees ensuring the proper ratio between field and house bees.
- Nasonov pheromones are used to attract swarms to a new hive and help orient returning foragers. These pheromones may also be detected by humans in certain cases. It has a sweet, citrusy smell.



Picture 1. Swarming bees have found a new home. These bees are “fanning” nasonov pheromones to draw the remaining bees in.

## Races of Bees

Honeybees (*Apis mellifera*) exhibit many geographical variations in anatomy and behavior. At least 26 such races, or subspecies, have been described in their native lands of Europe and Africa. Honeybees in the U.S. are non-native and have been imported from several of these subspecies (Example: *Apis mellifera carnica*).

The 26 subspecies of honeybees are divided into four major groups. At least one subspecies from each of these four groups have become well-known and are the most common honeybees in the U.S. The Italian and Carniolan bees originated in southeastern Europe

and are the most common honeybees in the U.S. Less common is the German black bees originating in northwestern Europe. The Caucasian bee comes from the trans-Caucasus region east of the Black Sea. While the fourth grouping of honeybees comes from Sub-Saharan Africa, it is represented in the U.S. by a hybrid of one of its seven sub-species, *Apis mellifera scutellata*, called the Africanized honeybee.

German black bees were the first brought to the New World by European colonists. However, because of their highly defensive nature, inferior reproductive capacity and susceptibility to diseases, they were generally replaced by Italian bees, starting in the mid-1800s. Today, most commercial queen producers advertise either Italian, Carniolan or Russian honeybees for sale. Russian honeybees are not a distinct subspecies, but are instead descendants of bees kept in their non-native range of Primorski in Russia and later selected by the U.S. Department of Agriculture's Agricultural Research Service for resistance to varroa mites.

All honeybees in the U.S. should be considered crossed descendants of original subspecies, but may have more or less genetic characteristics similar to a described subspecies. The following sections generalize what we think of when we describe Italian bees or Carniolan bees, however these are simply generalizations based on centuries of experience with imported bees kept in relatively close proximity to one another. Therefore, variation is expected and characteristics may not necessarily relate to subspecies in their native range in Europe. For example, a recent import of Italian germplasm to Washington State University yielded dark bees with a propensity to sting, while we generally think of Italian bees as being light in color and gentle.

## The Italian Honeybee

Originating in southern Italy, the Italian is one of the two most widely used bees in the U.S. They can have from three to five bands of yellow on the abdomen, bordered with black. The rest of their body is colored by varying shades of yellow. Those with three bands are sometimes called leather-colored Italians; those with five bands, golden. Italian bees are prolific, industrious and generally have a gentle disposition.

### Advantages

- Compact brood pattern, producing a large workforce for nectar and pollen collection.



Figure 12. Italian queen with Italian workers.

- Excellent foragers.
- Do not readily swarm or propolize hive parts together.
- Relatively gentle and calm.
- Light color makes queen easy to find.

### Disadvantages

- Population builds up slowly in spring; may not adequately harvest early honey flow.
- Greater tendency to rob weaker colonies.
- Greater tendency to drift, with the potential of spreading diseases and pests, and causing uneven colony populations.
- Brood rearing continues after end of major honeyflow. If rearing occurs in late fall, colony may starve due to overabundance of brood and lack of honey.
- May be susceptible to many diseases and pests.

## The Carniolan Honeybee

Carniolans are the other most widely used bees in the U.S., and can have grayish-black bodies with light hairs. Queens and drones are darker than workers. Workers can have bands and have a longer tongue length than some other subspecies. They originated in Yugoslavia and Austria and perform well at cooler temperatures. Carniolans have become more popular in the U.S. in recent years.

### Advantages

- Populations increase rapidly in early spring; best for spring pollination and early honey flows.

- Brood rearing is reduced when available forage decreases; honey stores are conserved.
- Very gentle.
- They overwinter well because the queen ceases egg laying earlier in the fall than those of other races and they are frugal honey consumers. Therefore, more bees can survive on less food stores.
- Less tendency to rob.
- Forage earlier in the morning and later in the evening, and on cool, wet days.

### Disadvantages

- Greater tendency to swarm if overcrowded.
- Strength of broodnest more dependent on availability of pollen.
- Dark queen is difficult to find.

### The Caucasian Honeybee

Caucasian bees are dark with gray or brown spots and short, gray hairs. They have the longest tongue of the European races, making them better pollinators of certain plants and better foragers in areas where forage is marginal.

### Advantages

- Build large colonies.
- Forage at cooler temperatures.
- Brood production ceases earlier in the fall, conserving stores and enhancing winter survival.
- Reduced tendency to swarm.



Figure 13. Carniolan queen, marked with red paint, with Italian workers.

### Disadvantages

- Heavy propolizers.
- Population builds up slowly in spring; not best for early honey flow or early spring pollination.
- Although generally gentle, are persistently defensive if aroused.
- Dark queen is difficult to find.
- Potential to drift to other colonies, and to rob weak colonies.

### Italian Cordovan Honeybees

**Italian Cordovans** are reddish-brown and are bred for gentleness, disease resistance and superior production. Their attractive color and gentle nature make them popular for observation hives

Cordovan describes this color trait which is not limited to Italian bees, although most bees with the cordovan trait are advertised as Italian bees. The cordovan coloration is caused by a single recessive gene. If a pure cordovan bee is crossed with a non-cordovan bee, the hybrid daughters will not have the cordovan color.

### Breeding Lines or Strains

Bee breeders have produced numerous lines or strains by selecting their breeding stock for traits they desire. The resulting bees are sometimes described by a unique name, or are often described by the business name and either being Italian or Carniolan. So for example, C.F. Koehnen & Sons' Italian bees are likely different from Italian bees from other breeders. Discussed next are a number of other popular breeding lines.

**The Buckfast bee** was developed by Brother Adam of the Buckfast Abbey in the United Kingdom to exhibit several desirable characteristics. It is tolerant of tracheal mites, relatively gentle, has a low tendency to swarm and to propolize, overwinters well and is resistant to diseases. Buckfast bees have been imported into North America with large scale Buckfast breeders and producers located in Canada and the U.S.

**The Starline hybrid**, no longer available, was produced by developing separate pure lines for specific traits. The lines were then crossed to

produce hybrid queens for sale and use in production colonies. The resulting hybrid vigor increased their ability to build up rapidly in the spring and produce strong populations. They were gentle and did not overly propolize.

Unfortunately, the progeny of outcrossed daughter queens of the hybrid mothers (those daughters mated with drones of unknown genetic origin) may not exhibit the desired characteristics or may have undesirable characteristics, such as being overly defensive. Therefore, requeening every year or every other year is necessary with hybrid queens to retain the desired traits.

**Minnesota Hygienic** bees were developed by Marla Spivak's lab at the University of Minnesota. These bees have been selected to hygienically remove brood damaged from mites and some brood diseases, thereby interrupting the life cycle of mites and diseases. This line began from 'Starline' stock.

**The Russian bee** was brought by the USDA Agricultural Research Service from far eastern Russia where bees had been kept for a long period of time with varroa mites. It was assumed (and confirmed) some naturally selected resistance to mites was present in this population. Later, these bees were selected in the U.S. for additional resistance to varroa mites.

**The VSH bee (Varroa Sensitive Hygiene)** is another bee developed by the USDA Agricultural Research Service lab in Baton Rouge, La., It exhibits genetic traits that suppress mite reproduction, which reduces the severity of varroa mite infestations. Both dark and light lines of this bee exist. The lighter is assumed to be more Italian like and the darker assumed to be more Carniolan like.

## Colony Performance Standards

A strong colony has these characteristics:

### 1. Bee Population

#### A. Prolific queen

- (1) Full brood pattern on frame
- (2) Few skipped cells
- (3) 8 to 16 or more frames of brood (beginning of honey flow from April 10-21)

#### B. Worker bees

- (1) 60,000 to 100,000 bees

- (2) 30,000 to 40,000 or more field bees
- (3) 3,500 bees per pound or frame
- (4) 20 full frames of bees in brood chambers
- (5) 10 frames of super (extra chamber) covered with bees

#### C. Drone bees

- (1) 1,000 or more in strong colony
- (2) Appear in March
- (3) Disappear in October
- (4) Seasonal (45-day life span) for individual drones

**2. Disposition** — Gentle bees that are easy to work with; very little tendency to sting under good flight conditions.

**3. Low-level Swarming Instinct** — Swarm prevention can be a major problem. Colonies with a low-level swarming instinct are most desirable.

**4. Resistance to Mites** — Both tracheal and varroa mites.

**5. Honey Production** — Colonies that produce 100 pounds or more of surplus honey are most desirable. This measure is above the 40-60 pounds of stores for the bees to use. Productive colonies can do extremely well if moved to the mountains from low elevation areas by July 1. Double cropping of productive colonies is definitely recommended for increasing your honey production per colony.

## Beekeeping Protective Gear

Some beekeepers wear as much protective gear as possible to reduce the number of stings they receive. Others wear very little protection and do not worry about stings. The choice is yours. However, as a new beekeeper, you may want to start by wearing a full coverall and gloves. As you become more skillful and confident, wear less and take the gloves off. The amount of protection varies with the activity being done and with the temperament of the bees.

**Veils** — A veil should be worn at all times to avoid stings on the face that are painful and dangerous, especially near the eye, in the nose and in the ears. A sting on the eyeball could result in a permanent loss in vision. Wear a veil at all times.



Types of veils: Folding and round veils are made of wire mesh that fit over a helmet worn on the head and are secured in place with drawstrings tied around the waist. An Alexander-type veil requires no helmet, usually attaching to the head with an elastic band. The lightweight “tulle” veil is made of fine nylon mesh that is worn with a helmet or other hat. There are also veils made with combinations of cloth, nylon or wire mesh that zip onto a coverall

**Helmets** — Helmets are usually adjustable to head size. They are made of metal, plastic or a “breathable” tight-weave mesh. Helmets support veils that fit over them and provide space that keeps the veil away from the face.

**Clothing/ Bee Suits** — Choose loose-fitting, long pants and a light-colored, long-sleeved shirt with a smooth finish. Khaki or chambray material works well for the shirt and khaki or faded jeans work fine as pants. Avoid textured materials and animal-origin materials like wool, fur or feathers, because the odor may cause defensive behavior. Textured materials may entangle a bee’s stinger, causing a bee to sting while smooth materials will not. Wear boots that come over the ankle. It is quite a sensation to feel a bee crawling up your leg under your pants. Secure the bottom of the pants over the boots and the sleeve cuffs over the wrist with straps, tape or rubber bands to prevent bees from entering.



Figure 14. Beekeepers wearing different types of protective gear.



Figure 15. Folding veil.



Figure 16. Alexander-type veil.

**Gloves** — Although some experienced beekeepers do not wear them most of the time, gloves can be important to prevent stings. Most stings a beekeeper will receive are on the hands when picking up frames covered with bees. Bees can sting through gloves, even ones made from leather. Gloves are made of cloth, leather or plastic and often have a gauntlet base that extends almost to the elbow, usually ending with an elastic band. Choose a pair of gloves that fit well, otherwise they will be so awkward that clumsy movements may increase stinging.

## Hardware and Tools

**Hive Tools** — Hive tools are used to pry apart hive parts that bees regularly glue together. The traditional hive tool resembles a pry bar with a flat end and a bent scraper end. Another popular tool is called a frame lifter because one end is inserted under a frame end bar while resting on the adjacent frame. The downward motion of the tool uses leverage to loosen that end of the frame. These work very well to remove the first frame during an inspection. Figure 17. Standard hive tool on top. Frame lifter on bottom.



Figure 17. Standard hive tool on top. Maxant tool on bottom

**Smoker** — A smoker is a very useful tool, allowing the beekeeper to produce smoke that “calms” the bees. A smoker has a cylindrical chamber with a bellows attached, topped with a hinged lid formed into a spout. The chamber, where a fire is built, is made of metal, usually stainless steel. When the lid is closed, and the bellows compressed, a stream of smoke can be directed wherever it is needed. We suspect the calming effect occurs because smoke causes bees to engorge with honey, then they are less likely to be defensive. In addition, the smoke may disorient and confuse the bees by interfering with sensory reception, especially for odor.



Figure 18. When smoking a colony, position the smoker spout at the colony entrance.



Figure 19. Use small puffs of smoke.

Smoke can also be used in small amounts to direct bee movements. For example, a few small, well-placed puffs will cause bees to move away from the end bars long enough for the beekeeper to remove the frame without crushing a bee or two in the process. Excessive smoke disrupts the colony, causing too much bee movement on the frames. This makes some activities, such as queen finding, much more difficult.

Pine needles, wood chips or shavings, dried grass or leaves. Do not use materials of animal origin, such as wool fabric, fur or feathers.

## Top Bar Hives

Top bar hives are a simple alternative to standard langstroth hives. They consist of a rectangular box with wooden slats laid across the top along which the combs will hang. Foundation is not used but the top bars will ideally have a wax coated ridge to prompt comb building in the proper place. The concept may be several thousand years old. Today there are two main varieties named for their countries of origin: The Tanzanian hive which has four vertical walls and the Kenyan hive which has sides that slope inward. Although the Kenyan hive is more difficult to produce it is superior because it exploits the natural reluctance of bees to attach comb to the floors of their hives. As long as the angle between the floor and the walls of the hive is 120° or greater, attachment of brace comb to the walls will be limited. Advantages and disadvantages of a top bar hive are summarized below.

Pros and cons of using a top bar hive	
Advantages	Disadvantages
Cheapness and ease of construction.	Combs must be crushed and strained to extract honey.
No lugging supers off to get at the brood nest.	Lower honey production.
The lack of gaps between the bars means less of the hive is open at any time.	Less commonly used so it's more difficult to get high quality advice.
Reduced storage requirements because honey supers aren't used.	Difficult to move combs around as they are rarely drawn perfectly.
Harvesting honey produces lots of light beeswax.	Requires more frequent maintenance.
	Comb lacks support of a wooden frame and can be very fragile.

## Wooden Equipment

### Bee Space Is Important

Traditional hive parts are made from wood. However, plastic and polystyrene are now common materials for various hive parts. The design and dimension of hive parts are based on the concept of bee space. Bee space was first recognized and promoted by the Philadelphia minister Lorenzo Langstroth in the 1850s, when he introduced what is commonly known as the Langstroth hive. Langstroth discovered that bees build excess comb in a space larger than 3/8 inch. Bees will fill any space less than 1/4 inch with propolis. Therefore, a space between 3/8 inch and 1/4 inch is in a range of acceptable bee space, with 5/16 inch an average that is most acceptable by beekeepers. A Langstroth hive would have a 5/16- or 3/8-inch space separating each frame and the frames from all other hive parts.

### Parts of a Standard Hive

A standard hive includes a bottom board, a hive body or two containing frames, several honey supers containing frames, an inner cover, and an outer telescoping cover that fits on top. The terms "hive body" and "super" are functionally interchangeable. They are both basically wooden boxes. Normally the "hive body" refers to the larger box placed directly above the bottom board, usually associated with the brood production area. Supers are the boxes that are normally placed above. Supers are available in three sizes; a deep is the largest; a medium, also called an "Illinois," of intermediate size and a shallow, the smallest size. Please see diagrams and figures illustrating these parts and their dimensions.

### Area for Brood Chamber and Supers

Two deep or three medium supers are recommended as the best brood-rearing space. One deep and a medium could also be used and one deep plus a shallow would be the minimum amount of brood-rearing space. Three to four supers are usually required for honey production.

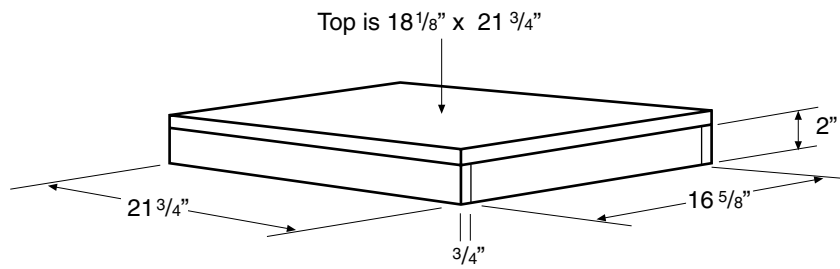

**Outer cover.**

Figure 20.

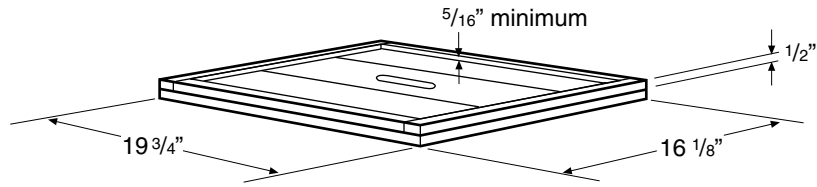

**Inner cover.**

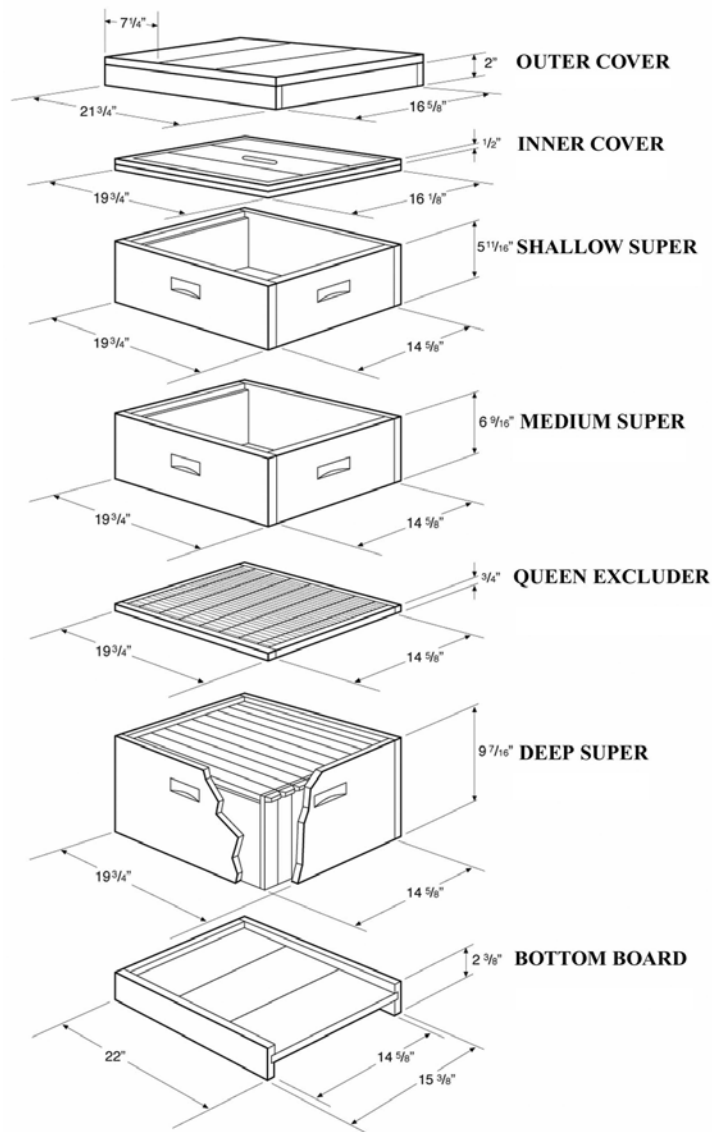
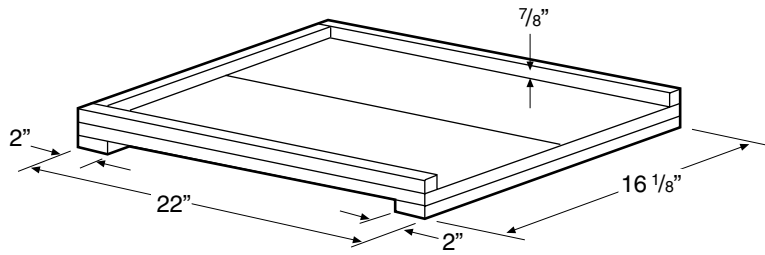
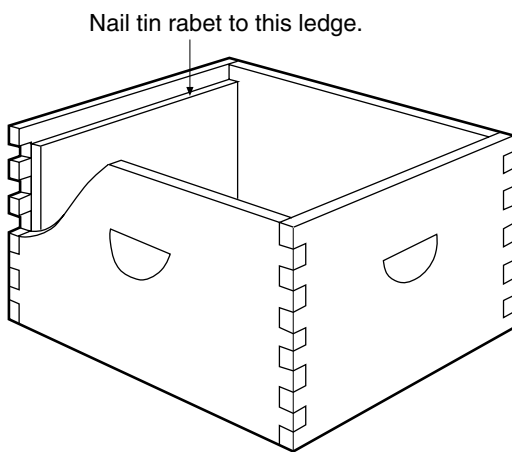

Figure 21. The parts of a modern honeybee hive.



**Bottom board.**



**Hive body  $9 \frac{7}{16}$ " deep by  $16 \frac{1}{4}$ " wide by  $19 \frac{3}{4}$ " long.**

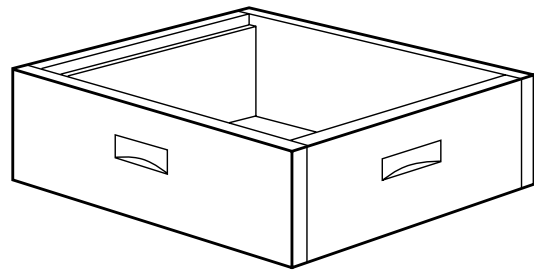

**Shallow super  $5 \frac{11}{16}$ " deep by  $16 \frac{1}{4}$ " wide by  $19 \frac{3}{4}$ " long.**

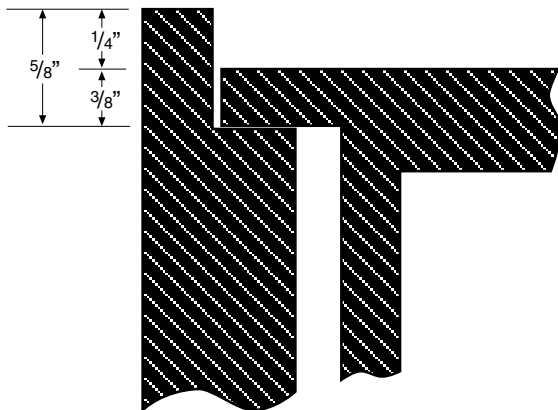

**The hive body ends are cut out  $\frac{7}{16}$ " wide by  $\frac{5}{8}$ " deep across the inside top edge.**

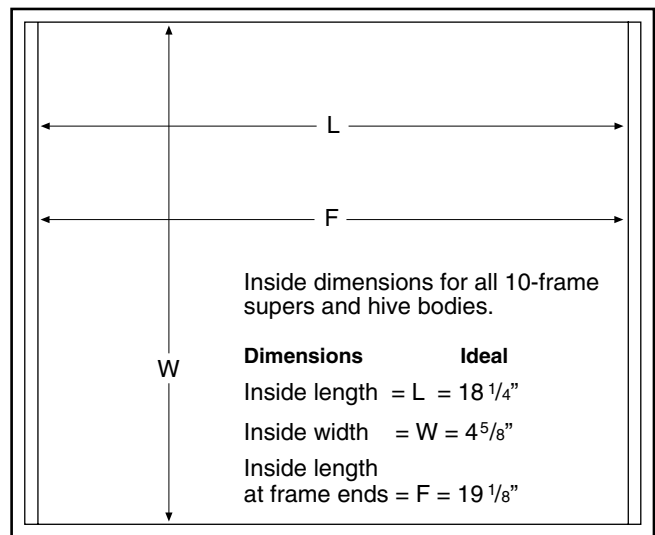

**Top view of super on hive body.**

Figure 22.

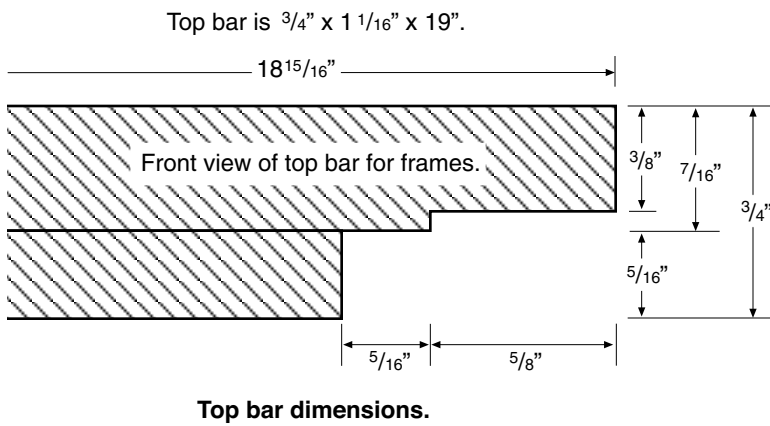
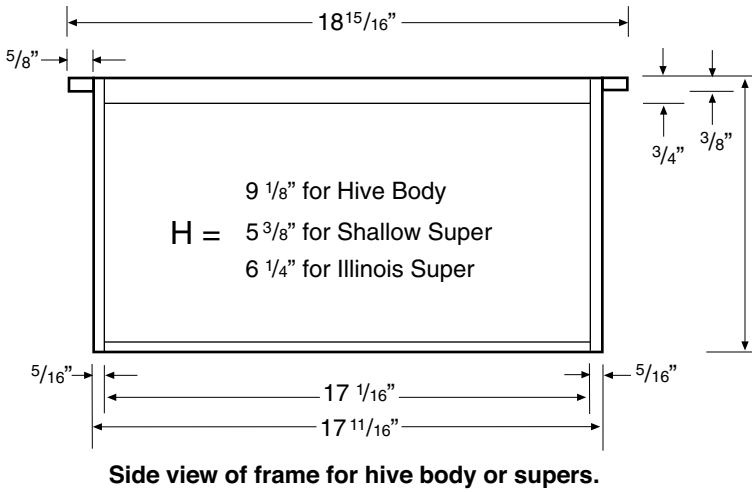
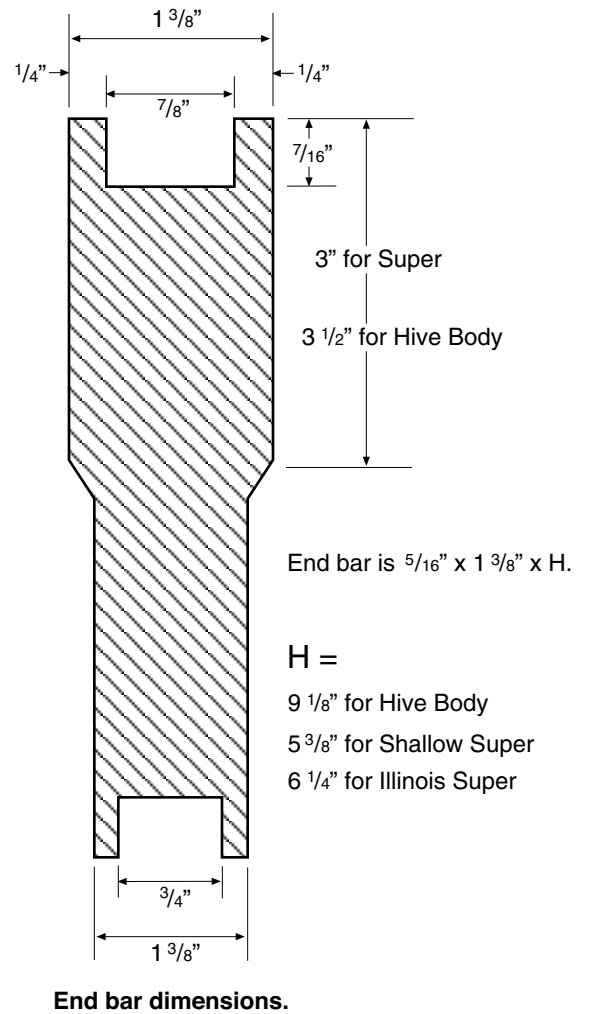
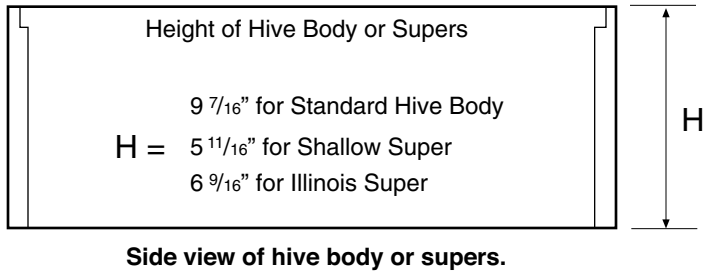

Figure 23.

## Working With a Honeybee Colony

Before entering the apiary, suit up in appropriate attire. If not wearing a bee suit (see equipment section), dress in light-colored, cotton or rip-stop nylon clothing. Always wear a veil. Wrap the bottoms of your pants legs around the top of your boots and secure them in place with a rubber band or tape. Bees drop from handled frames to the ground and may crawl up your legs as you work around the hive. Gloves are optional. Beginners should wear gloves until they feel confident without them.

**Light your smoker** and fill the chamber with fuel.

**Approach the colony** from the rear or the side. Always work the colony from the rear or the side. Apply two gentle puffs of smoke into the entrance. Pry the outer cover up 2 to 3 inches along one side with your hive tool. Lightly puff under the outer space and replace it. Wait about 30 seconds before removing the outer and inner covers.

**Gently remove the outer cover** and place it on the ground, upside down, near the colony. It can be used as a base for stacking supers or brood chambers that you remove as you inspect the colony. Gently remove the inner cover and lean it near the entrance so that clinging bees can reenter the hive. The inner cover is often more tightly stuck to the top box with propolis. Use your hive tool to pry it off. Do not block the entrance with the inner cover.

When removing and handling frames, **work with slow, steady movements**. Avoid bumping or shaking motions that may shake bees off the frame. Lightly smoke bees to manipulate their movement, such as when you need to examine frames for eggs. Before replacing a frame, smoke the bees out of the way to avoid crushing them.

**Do not leave colonies open for too long.** Bees may get overly defensive and an open hive may initiate robbing behavior. Before closing the hive, use smoke to move bees back onto the frames from the edge and outside walls of hive bodies.

Open a colony when the temperature is 55 degrees F or warmer, the sun is shining, the bees are flying and the wind is calm. However, do not expose frames of brood to cool temperatures for more than a few moments by removing them from the hive. Open and inspect colonies once a week during spring build-

up and honey production. Colonies should be opened and inspected one or more times each month from February through November.

## Inspecting a Colony

Pry the outside frame of the brood chamber loose. There are normally fewer bees and brood on the outside frame. Removing this frame first frees up space in the box for you to be able to pry additional frames apart before lifting them from the box. Frames should be pried sideways before lifting the end bars up and out of the hive to prevent breaking the end bars, if they are stuck with propolis.

Remove the frame from the body and hold it in front of you with one hand on each end of the top bar. If possible, position yourself so that the sun is shining over your shoulder and onto the frame. Observe the bees and the frame. If this frame does not have brood or the queen, it can be placed next to the hive and additional frames removed and then replaced one at a time. Brood removed from the hive for long periods of time on cool days will chill the brood, killing it.



Figure 24. Inspecting a frame of brood.

### Inspect the brood frames for:

- Healthy larvae. Larvae should be pearly white. Gray, yellow, brown or black larvae are diseased, chilled or injured.
- Eggs standing in the bottom of cells. Recently laid eggs will be standing on end in the bottom of cells, one egg per cell. As they age, they gradually fall to one side. Two or more eggs on the sides of the cell are from a laying worker.
- Cell caps of healthy brood. These will be convex and tan. Cell caps of unhealthy brood are often concave and perforated with small holes.
- Area of cells with brood. A prolific queen will have a laying pattern of brood with very few skipped cells over most of the frame. The pattern should be compact and in a semicircle, usually occurring over the bottom half of the frame.
- Honey and pollen stores. Pollen should appear adjacent to the brood pattern. Adequate honey stores will vary with colony size. Honey is stored in cells adjacent to pollen and above the brood area.

Removing and inspecting all of the frames that contain brood can help you develop a clear picture of how colonies develop. However, just inspecting two brood combs per colony can be a good indicator for the health of the colony. After inspection of a frame, place it in the hive body toward the side from which you removed the outside frame. After completing your inspection, replace the frames in their original order and close the hive.

When you open a colony for inspection, you also can perform other tasks necessary for colony maintenance, such as feeding, treating with antibiotics or miticides, replacing damaged combs with frames containing new foundation, adding an empty super, or removing a super of honey. Prepare the items you need in advance and have them near when you open the colony.

Remove and inspect all of the frames that contain brood. After inspection of a frame, place it in the hive body toward the side from which you removed the outside frame. After completing your inspection, replace the frames in their original order and close the hive.

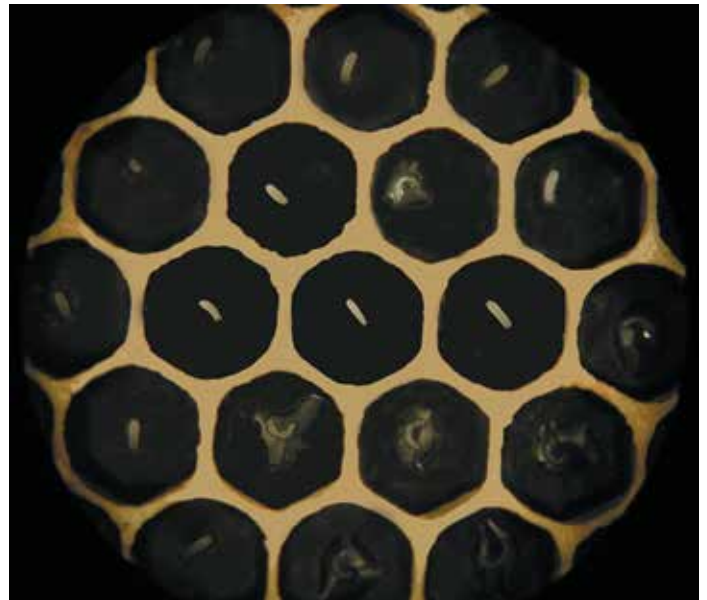

Figure 25. Honeybee eggs and young larvae.



Figure 26. A healthy brood frame.

When you open a colony for inspection, you also can perform other tasks necessary for colony maintenance, such as feeding, treating with antibiotics or miticides, replacing damaged combs with frames containing new foundation, adding an empty super, or removing a super of honey. Prepare the items you need in advance and have them near when you open the colony.



## A note on small cell foundation

Recently there has been a movement to eliminate the use of typical hive foundation in favor of small cell foundation. Some forgo foundation all together and allow the bees to freely draw comb. The reasons for this are varied, both explicit and vague. One idea is small cell foundation provides less room for the destructive varroa mite to live in capped brood cells, reducing mite presence. This idea has been shown to be untrue.

Published research trials of from three separate universities — the University of Georgia, the University of Florida and Cornell — all conclude that small cell does not reduce varroa mite numbers.

Another reason some beekeepers give for using small cell or foundationless hives is that it causes bees to regress to a smaller more “natural” size. This assumption is also a dubious one. Michael Wilson kept foundation-less colonies in Tennessee for three years while allowing them to build all new combs each year. After 1,064 measurements he found bees without foundation build about the same size cells, or slightly larger, than bees on standard foundation. However, it has been shown that Africanized bees naturally build smaller cells. It is also possible that some populations of predominantly European bees may naturally build smaller cells because there is evidence that the various subspecies native to Europe had varying cell sizes. A review of the literature shows that the size of cells on the earliest foundation mills were based on natural cell sizes and that size is around 5.3mm, the same size as modern, commercially available foundation.

### Items you should bring to the apiary or that you should keep on hand:

- Extra hive tool or tools, gloves, veil, bee suit and smoker.
- Matches or lighter.
- Dry smoker fuel.
- Extra frames with drawn comb or new foundation, and extra hive bodies.
- Container to collect wax scrapings or propolis.
- Jars or sealable bags to collect bees for mite testing or comb for disease identification.
- Queen excluders.
- Entrance reducers.
- Heavy fabric, such as burlap, or extra inner or outer covers to protect uncovered colonies or supers from robbing bees.
- Newspaper for uniting colonies.
- Permanent marking pen or pencil to make notes on the hives or in a notebook.
- Extra queen cages and queen marking paint.

- A sting kit for those allergic to bees (Epipen), first aid kit and other medications for the beekeeper.
- Water to stay well hydrated.

## Starting Your Colony

There are several methods to acquire bees, including buying an existing colony, starting from a small “nucleus” colony purchased from another beekeeper, installing a package purchased from a bee supplier, capturing a swarm, and splitting an existing colony. Let’s look closely at the latter three possibilities.

### Installing a Package of Honeybees

Starting a honeybee colony with a package purchased from a reputable producer is a good way to ensure the colony you have is healthy and of a particular race or hybrid. A package should be installed in the early spring to take advantage of the nectar flow.

A package consists of a known amount (by weight) of bees and a caged queen shipped in a screen box containing a feeder can of sugar syrup. Packages are normally 3 pounds in size. One pound contains about 4,000 bees. They should be ordered long before you want to receive them, ideally in the fall.



Figure 27. A nuc with a moving strap in place.



Figure 28. Installing a package of bees.

## **Receiving a Package**

Inspect the package. If the majority of the workers are dead or the queen is dead, contact your supplier for instructions and possible replacement. If all is well, place the bees in a cool, dark place until early evening.

## **Installation**

The cage should be installed into one single deep or two medium hive bodies. You can use all new foundation, drawn comb or a mixture. If using a mixture, put the drawn comb in the center to facilitate egg-laying there. Make sure the drawn comb was taken from healthy colonies.

In the early evening, take the package to the apiary. Spray more sugar solution onto the sides of the package. Remove the outer and inner covers from the hive. Remove four or five frames from one end of the hive body or both bodies (medium body). Spray sugar solution lightly onto the remaining frames and on the inner walls of the hive body.

Remove the top cover and feeder can from the package. Remove the queen cage from the package and cover the opening of the package. Remove the cork from the end of the queen cage plugged with candy and use a nail to poke a hole in the candy, being careful not to harm the queen. Suspend the cage, candy end up, between the two center frames of those remaining in the hive body. For medium hive bodies, suspend the cage within the bottom hive body. Remove the cover from the hole in the top of the package, shake about a cupful of bees onto the queen cage then place the package, with the hole end up, in the open space within the hive.

Replace the inner cover and place a feeder can with a 2:1 sugar solution and Fumidil-B (according to label directions) over the opening in the inner cover. (Be sure the queen cage is not directly below the inner cover opening.) Place an empty super on the inner cover around the feeder can and cover this with the outer cover. Partially block the hive entrance with an entrance reducer or grass and leave it blocked for about a month.

Check the queen cage in three days to see if the queen has been released. If she has not been released, remove the screen, or cork, and let her walk into the colony. Then, do not disturb the colony for 10 days. At this time, examine the frames for a brood pattern. If a brood pattern and eggs are found, then

you have successfully installed the package. Remove the package container and replace the frames removed earlier. Close the colony.

### **Other Methods of Bee Installation**

There are variations of the installation method mentioned above, including differences in releasing the queen and the workers. After suspending the queen cage, gently shake the bees from the package onto the bottom board. Lightly mist the bees with sugar solution. Replace the frames, being careful not to crush any bees. Close the hive and proceed as above. Another method of queen introduction is to place the queen cage on the bottom board, then shake the remaining bees onto the bottom board.

### **Starting by Collecting a Swarm**

**What Is a Swarm?** Swarming is the natural mode of reproduction for a honeybee colony in spring. Swarming is induced as bees increase their population size and require more space. A swarm usually consists of the old queen (sometimes a new one) and 50 to 60 percent of the worker bees in the swarming colony. Workers preparing to swarm engorge themselves on honey and force the old queen out of the hive. Changing weather conditions from cool and rainy to warm and sunny seem to stimulate the natural urge of bees to swarm.

Most swarms leave the colony in good weather between 10 a.m. and 2 p.m., fly to a nearby tree or bush and land on a limb. Immediately after landing and for the next 24 to 36 hours, the bees are very docile; they are interested in swarming, not in defending their colony. Scout bees come out of the cluster of the swarm and search the local area for a protected location for the colony. The scout bees communicate the information to the swarm and a “decision” is made, whereupon the bees leave the branch and proceed to their new location.

After arriving at the new location, or rarely if the swarming bees have failed to find a location (see Figure 30), the bees start to build wax comb and the queen lays eggs to start a new brood nest. After brood production commences, the new colony will become defensive of its new home.



Figure 29. A swarm in a pine tree.



Figure 30. Bees on exposed comb.

## Preparing for a “Swarm Call”

As a beekeeper you may be contacted by neighbors, businesses and the county Extension office as early as the month of March to go out and collect a swarm. This request is a “swarm call.” Collecting a swarm can be exciting, fun and a good way to start a new colony with less expense. However, you must be prepared to go and get the swarm at a moment’s notice, because the swarm may depart quickly, not “waiting” for you to get ready. You may want to give your name and phone number to your county Extension office so that your name can be put on a list of beekeepers who are willing to retrieve swarms if you are an experienced swarm collector.

- Anticipate the call by finding a container to hold the swarm (a cardboard box will do, but a hive body with bottom and top works better); preparing sugar syrup (1:1 sugar/water) in a squirt bottle; and collecting a smoker, fuel and matches, a strap to hold lid/top on your container, a bee veil, and a ladder.
- When the person calls announcing he or she needs someone to retrieve a swarm, you should tell the caller not to disturb the swarm or spray it with water, soap or pesticide.
- The caller may be excited or even alarmed. Calm the caller by explaining what is happening and that swarming honeybees are not defensive or dangerous unless disturbed.
- Explain that a swarm will usually move from the original location within 24 to 48 hours; therefore, if a beekeeper is not available to collect the bees from a homeowner’s property, the bees will normally leave without causing a problem.
- Ask questions to improve your chance of success in collecting the swarm.

### Questions to Ask About Swarms:

- Are these really honeybees? Ask them what the cluster looks like. You do not want yellow jackets or hornets. Has anyone disturbed the cluster?
- Get permission from the landowner/homeowner to collect the swarm from his or her property.
- Be sure to write down the name, address and phone number, including work number of the homeowner or someone who will be on site.

- Ask for directions of how to find the swarm location, including where on the property.
- How long have the bees been there? If it has been there for more than two days, it is probably not a swarm and could instead be an established colony (a swarm that has begun to build comb), and therefore may be defensive when removing them.
- How high off the ground are they? Will you need a ladder?
- How big is the swarm (beach ball, football size, etc.)?
- Ask the caller if it’s all right (or acceptable) if you snip a branch of the tree or bush holding the swarm.

## How to Collect a Swarm – This Is the Fun Part!

Let’s start with an “ideal swarm” example to start with. This swarm has formed in a small tree, 5 feet above level ground in a fenced yard. The homeowner reports the swarm has been there only 20 minutes.



Figure 31. An easy swarm to collect.

- Place the whole cluster of bees, including the queen, directly into an empty hive body or nucleus (smaller version). This way frames can be gradually added to this “colony” and there is no need to shift the bees into a hive later. Some beekeepers like to lay the cluster down on a sheet in front of the hive and let the bees walk into the hive on their own. This is your choice.
- Mist the hanging cluster of bees lightly as well as the inside surfaces of the hive body and frames (those that can fit in easily with the swarm) with 1:1 sugar-water syrup.
- If the bees are clustered on a low branch, snip it and carefully lower the branch and bees into the hive.

- If it's not possible to cut the branch, then place the hive body below and surrounding the bottom of the cluster, if possible. Then shake the branch to dislodge the bees into the hive body. If shaking isn't an option, then gently brush or scoop the bees with a gloved hand down into the hive body.
- Add frames gradually to the middle area to fill the box as bees move up onto frame surfaces.
- Carefully look on the branch for a missed queen and scoop any clusters gently into the box.
- Crack the lid on the box for a few minutes to allow stragglers to find the new colony.

You may need to leave the new colony in this location overnight if many bees are flying around. In other situations everything happens quickly and you can put them in and leave within a few minutes. This timing may depend, in part, on how long the swarm has been in this location.

Attach the top to the hive body and secure window screen in the entrance with staples to keep bees inside while providing ventilation. Strap the unit together and move it to the new location.

You will need to modify this method to fit your unique situation. Not all swarms cluster this close to the ground on an easy-to-reach branch. You will need to decide if the swarm is too high or on a structure that is out of reach for safe retrieval. We have collected swarms from interesting places such as vehicles, grocery shopping carts, mailboxes, statues and from eaves of buildings.

## ***Splitting or Dividing a Colony***

### **Why Divide?**

The most common reasons for dividing a colony are swarm prevention and the need to increase colony numbers. A strong colony can be divided into two or three colonies (splits). The number of splits will depend on the amount of brood and adult bees present in the parent colony. For each split, you need three to five frames of brood, a couple of food frames with pollen and honey, and a sufficient number of adult bees to care for the brood. Be careful not to split a colony too many times or wait until it's too late in the year, because the small colony needs time to build up for winter.

**Tip:** Lightly misting the frames and bees in the splits with a 1:1 sugar-water solution will calm the bees, and occupy them while they get acquainted with their new home, especially if you intend to mix brood from one or more colonies to form the split.

### ***When Should a Colony Be Divided?***

A colony can be divided when it has a large population of bees, at least 10 frames of brood and appears overcrowded. When you open a crowded colony, bees tend to "pour over" the top of the frames. In the spring, a large colony preparing to swarm is an excellent candidate to divide. Prior to swarming, a colony produces many (sometimes 10 or more) queen cells (called swarm cells) on the bottom portion of frames in the brood area. Once the queen cells are capped, swarming is imminent unless you act quickly to "convince" the bees that they have already swarmed. Dividing the colony is one method to reduce overcrowding in the brood area and in the honey storage area as well. Prior to making the divides you need to determine how many can be made and how to provide queens for the parent colony or splits. To provide a queen you can use queen cells or eggs from the parent colony or purchase queens from a queen producer.

### ***To Divide a Colony With Queen Cells:***

- Set up hive stands and organize all equipment to be used for the new colony or colonies. You will need bottom, inner and top covers, supers, and frames. If using foundation when there is no honey flow, you will need to feed sugar syrup (see section on feeding bees).
- Open the parent colony with minimum smoke and find the queen. Place the frame with her in the new colony to give the parent colony the illusion that the queen has swarmed. Determine the number of frames of brood and food in the colony being divided.
- Place the split **without** the old queen in the location of the parent colony. The older foraging workers will return to the parent colony.
- Carefully remove brood frames that contain queen cells to an empty hive body. Queen cells are easily damaged. Do not leave the frame exposed to sun and do not turn the queen cells upside down.

- Place a frame having at least two or three large, well-shaped queen cells into the queenless split adjacent to other brood combs very small queen cells can be destroyed.
- Place three to five frames of brood near the center of the super in each new colony and provide enough bees to completely cover the brood. The brood and queen cells must be incubated (kept warm) by the adult bees for them to develop and hatch.
- Add at least one frame of pollen and one frame of honey, placing them outside the brood.
- Provide at least two frames of empty drawn comb (preferred) or two frames of foundation on the outside of the brood area.
- Place a super, containing drawn comb or foundation, above the brood chamber, on the colony at the original position if it is sufficiently strong. More combs than a colony can protect increases your chance of problems with the small hive beetle.
- Add a top feeder if there is no honey flow (see section on feeding bees).
- If the queen cells were recently capped, they will emerge in six to seven days and then it will take another two to three weeks for the queen to start laying, depending on if the weather is suitable for mating flights. Check the split with queen cells three weeks after it was made for a laying queen. Eggs and young larvae may be present. If none are present, check again a week later, if none are present then the split probably failed to raise a mated queen.

The divide made with the mated queen can be checked soon after the split was made. Check it in a few days to see if sufficient adults remain with the colony in its new location. If so, an additional box can be added since the colony with the laying queen can grow rapidly.

### ***To Divide a Colony and Produce a Queen From Eggs:***

Follow the procedure above; however, rather than providing splits with queen cells, you will be giving them frames with eggs to make their own queen. Make sure the colony that will raise queen cells has a

large number of adult bees to be able to raise healthy queen cells. If relocating the queenless split away from the original stand (but still in the same apiary), you will need to shake frames of nurse bees (located on the brood frames) into the split. There should be many more bees in the queenless split you are moving than you need since many bees will return to the original location.

If the colony you are dividing has NOT already begun raising swarm cells, the colony with the queen can stay at the original location, since a swarm is not imminent. Reducing its strength with the split may now prevent it from trying to swarm.

Six to 10 days later, you can check for queen cell formation, however. Be careful not to damage the queen cells. Do not frequently disturb the colony for the remainder of the queen rearing and mating period. If the colony uses the youngest eggs to raise the queen, it should take four weeks to have a mated, laying queen. The amount of time could be slightly longer if the weather is poor when the mating flights should occur. If the bees use larvae (hatched eggs) to raise queen cells, then the time it takes for the queen to start laying should be four to six days less. At four weeks after the split was made is a good time to start looking for eggs and larvae. Your split will have needed to be made sufficiently strong to go this long without a laying queen.

### ***Dividing a Colony and Requeening With Purchased Queens.***

**Follow the procedure for dividing as explained above with these changes/options:**

- If you plan to put new queens in both splits, order new queens in advance. Place the queen shipping cage, with the cork removed from the candy end, between two frames of capped brood in each queenless colony (see section on requeening). Return in three days to see if the queen has been released. If she has been released, do not disturb for 10 days, then check for a laying queen. If she is still in the cage, poke a hole through the candy to speed up her release and check again in three days.
- If you want to save the old queen, leave her in the original location and move the split to another location. When you divide the brood, give the split more capped brood, because these newly emerged

bees will accept a new queen more readily than will older workers.

- The new queen should begin laying within days after she is released by the bees, but frequent disruptions may cause the bees to replace her. If you want to ensure the bees cannot replace her, check for capped queen cells every seven days after the split was made and destroy all cells until they stop building them. However, if they reject the queen anyway, you will have prevented the colony from raising a suitable alternative.
- Smaller colonies more readily accept new queens as opposed to requeening full sized hives.

## Queen Marking

We feel that the advantages of marking the queen outweigh the disadvantages. A queen marked with bright colored paint is easier to find. You know the marked queen is one you introduced, not a supersede of unknown quality. You also know her age. Younger queens are more prolific layers and produce more pheromone that maintains colony cohesion, thus making the colony less prone to swarming and less susceptible to stressful conditions.



Figure 32. Marking a queen.

### How to Mark a Queen

1. Practice with drones until you have confidence that you can do it without damaging the drone. You do not want to squeeze the abdomen or thorax and you do not want to drop the queen.
2. Enamel model paint can be used, or many bee supply houses sell paint pens in enamel and water based that are suitable for marking queens.

3. Be prepared: have your paint and a helper's extra pair of hands ready, if needed, to hold the frame, unscrew cap from paint bottle, etc. If alone, shake paint and remove cap.
4. Grasp queen by the wings between forefinger and thumb of left hand so that her legs are suspended.
5. Place the forefinger of the right hand (nail side down) below her legs and she will quickly rest her legs on it.
6. Move the thumb of right hand on top of and trapping at least two legs (right side) with enough pressure to hold her (see photo). If you have the legs secure she will stop moving.
7. Release wings with left hand.
8. Daub the paint onto the center of the thorax only and hold her gently for 30 seconds to one minute before putting her back on the frame from which she was taken. Or, cage her to allow the paint to dry. Bees quickly remove wet paint from queens.
9. If a helper is available to daub paint, add your left thumb to trap additional legs of the queen (left side) and have the helper daub the paint on the queen's thorax.

## Requeening

### Why Requeen?

Some beekeepers requeen every year to take advantage of the better egg-laying performance and productivity of the young queen. While other beekeepers may allow an acceptable queen to head a colony as long as she can. A queen may lay for several years, but most queens are most prolific for the first year and decline during the second year, with performance falling drastically thereafter. A colony with an older queen is more likely to swarm than one with a young queen. Colonies with more prolific, young queens are less likely to be overwhelmed by parasitic mites. An inferior queen results in an inferior colony.

Colonies will often requeen themselves, especially if they have swarmed. If you let the colony requeen itself, you may end up with an inferior queen due to uncontrolled selection in breeding. Smaller, less vigorous queens are sometimes produced, especially in emergency, queenless situations where a weak colony has to suddenly raise a new queen.

A queen needs to mate with 12 or more drones over a one- or two-day period to accumulate the 5 million sperm she will need throughout her life. If the weather during her mating flights is cold or rainy, then drones may be scarce, resulting in less mating. This queen may run out of sperm later in the season and no longer lay worker eggs.

A virgin queen may mate with drones of inferior stock, resulting in a colony with poor honey production, increased tendency to swarm or one that exhibits excessive defensive behavior.

Consider requeening if the colony exhibits one or more of the following: unexplained low bee population, defensiveness, high swarming tendency, poor honey production or excessive drone production (excessive drones could mean the queen is running out of sperm to fertilize eggs).

### When to Requeen?

A colony can be requeened at any time during the warm season, but requeening is most successful when a nectar flow is on. Routine requeening is usually done in spring or late summer.

### The advantages of spring requeening:

- The old queen is easier to find due to smaller bee populations.
- Nectar/honey flows usually occur in spring. Requeening during a honey flow increases acceptance, and reduces robbing and defensiveness.

### The disadvantages of spring requeening:

- Spring rains and cool temperatures may prohibit opening the colony to search for the old queen
- If swarming has begun, you can miss capped queen cells as well as virgin queens that may be present or may be returning from mating.
- Very early queens from queen producers with wet cool springs may be of inferior quality due to poor weather conditions for mating.

### The advantages of August requeening:

- Colony starts the winter with young healthy bees and a new queen.
- Colony less likely to swarm next spring with a young queen.
- Spring population should be higher with a younger queen laying more in late winter and early spring than an old queen.
- If this queen fails, then you still have time to try again before cool fall weather.

### The disadvantages of August requeening:

- Harder to find old queen with large bee population.
- If no honey flow is on, then bees will be more defensive and prone to robbing.
- If no honey flow is on, then you need to feed all colonies in the apiary where you are requeening. If you feed only the requeened colonies, the strong colonies nearby may rob them.

### Queen Introduction

Many procedures have been described about how to install a queen. Some beekeepers use push-in cages and others use a division screen method, while shipping cages are the most common.

Many queen producers still ship their queens to beekeepers in the wooden Benton cage, or 3-hole cage. This cage has three circular cavities covered by screen and openings on either end that are plugged by corks. The cavity on one end of the cage is filled with sugar candy (fondant, a mixture of powdered sugar and water in a doughlike consistency). The plastic JZ-BZ queen cage is preferred by some. They do not require assembly by queen producers and fit easily between the top bars of two frames. The California



Figure 33. Benton cage and JZ-BZ cage.



mini-queen cage is a smaller wooden cage that can fit between the top bars of two frames.

In Benton cages, the new laying queen is normally shipped with around six attendant bees inside the cage to take care of her. With the smaller JZ-BZ cages and the smaller wooden California mini-queencage, queens are transported individually in their cage inside a shipping box with attendants that care for all the queens in the shipping box. When you receive the queens, inspect them to make sure they are alive. Add a couple drops of water to each cage on the screen, away from the candy end, to let the bees get water. For queens in shipping boxes, water should be sprayed or dripped on the screen sides. Research suggests that the attendants should be removed from cages before introducing the queen because they interfere with acceptance.

One way to safely remove attendants is to do it in a closed room with a window. You can wrap the cage except for the corked end without candy with a cloth, then remove the cork, making this opening the only place where light can enter. The workers and sometimes the queen will be attracted to light and come out. The quickest method is to turn off room lights, remove the screen and let all bees fly to the “lighted” window. Then replace the screen and put only the queen back inside.



Figure 34. Installing a queen in a shipping cage.

### Installing a Queen in a Shipping Cage:

- Locate the old queen and remove her from the colony. If you have difficulty finding queens, place queen excluders between supers with brood for four days before requeening. This method will confine the queen to one box. While searching for the queen, search also for eggs. The queen will be in the box

where you find eggs, because eggs laid before you added excluders have hatched (eggs hatch on the fourth day).

- Leave the colony queenless for 24 hours before introducing the new queen in her cage.
- Remove the cork from the candy end of the cage. One purpose of the candy is to delay immediate release of the new queen. Small colonies can take more than three days to eat through the candy in a queen cage while a strong colony can eat through the candy, and release the queen in one day. Ideally, the queen will remain in the cage for two to three days. During the time that the workers take to eat the candy and release the queen, her odors and that of her attendants have blended in with that of the colony. A new queen and her attendants have a different odor than that of the new colony and they may be treated aggressively if they are released too soon.
- Older recommendations say to press the side of the cage with the candy end up vertically into the middle of a frame of brood and move the adjacent frame of brood to “sandwich” the cage perpendicular, in between. This method leaves a small section of comb unprotected by adult bees and can result in small hive beetle becoming established in the unprotected areas, therefore it may not be a good method in Tennessee.
- Three-hole Benton cages can be placed on the top bars with a spacer, on the bottom board (if the colony is strong and the cluster will include the area of the bottom board), or hung between two frames, as long as the bees can move around it. Removing one frame will be required to provide enough room to place the cage between two frames.
- Plastic cages and the California mini-queencage are smaller and can be wedged between the top bars of two frames, or hung between two frames. Hanging strips are sometimes provided with both types.
- Putting the candy end up keeps any attendant bees (if included) from blocking the hole if they should die. If the candy end were down, dead attendants could block the queen’s exit.
- Wait three days before inspecting to determine if the queen is released. If she is not out and much candy remains or it is too hard, carefully poke a small hole through the candy to speed the process. Or, she can be released at this time.



Figure 35. Wire press-in queen introduction cage.

- Wait 10 days to search for her, and more importantly, for eggs, which indicate she is laying and has been accepted into the colony.

### Installing a Queen Using Press-in Cages

This method may no longer be acceptable in areas with small hive beetle problems, like Tennessee. The adult bees cannot patrol the combs under the screen push in cages and the beetle larvae can quickly begin destroying the combs. This scenario may not happen in every instance of use, but has been observed.

A press-in cage is a screen box with an open side made of eight-mesh (1/8-inch squares) screen. The size of the cage can vary with 4 inches by 4 inches being a large cage, while 2-by-2-inch cage is an acceptable size. Each edge is bent upward at a 90-degree angle to form a side that is 1 inch wide. The open side of the box is pressed over the queen on a capped brood frame that is about to emerge. No adult bees should be trapped under the cage with the queen. A few cells of honey also should be under the cage. New workers hatch out under the cage, take care of the queen and clean cells where she lays eggs. The cage is removed when eggs are found. During this several-day process, the queen and workers acclimate to one another and the queen is readily accepted. Caution: Make sure you put the cage over comb without holes. Workers can crawl through holes to get inside the cage before it's time to release the queen.

Another problem with this method is that bees may repair and remove comb that was destroyed when pressing in the cage, creating a gap where the queen and workers can enter or exit the cage, releasing the queen sooner than desired. It's therefore important to press the cage deeply into the comb.

## Moving a Colony

On occasion, you may need to move a honeybee colony. The move may be small, such as to another location in your apiary. Or it may cover a greater distance, such as to another apiary location, perhaps to take advantage of a particular nectar flow.

### To Move a Colony a Short Distance

Two methods may be used. The simplest method is to move the colony in small increments, about 1 yard each day. If a colony is moved more than a yard per day, returning foragers will be confused and you will lose some of the field bees. The second method involves removing the colony to a site several miles away for several days to allow foraging bees to "forget" the old location. Then return the colony to the new site in the original apiary where they will "learn," and become oriented to, the new location.



Figure 36. Colony secured with a locking strap.

### Secure the Colony Before Moving

Locking straps can be used to secure the colony for moving. A strap should be placed around an entire individual colony and tightened firmly. Additional strapping to secure the colonies within the transporting vehicle or trailer will be necessary to prevent movement or shifting during the move. For ease of use, strapping is the preferred method.

Stapling is another method of securing colonies for transport. All the outside parts of a beehive are stapled together with 2 3/4-inch hive staples. Drive the staples in at the four corners, fastening each part to the part above and below. This can be done during

the day in preparation for moving in the evening after dark. Using staples, however, will damage hive bodies, promote wood decay and agitate the bees during stapling.

Before moving a hive, remove the surplus supers of honey down to the brood chamber(s). Excess honey supers increase weight and make strapping more difficult.

### ***Ventilate the Bees for the Move***

If your bottom board is screened (instead of solid), the screened bottom will provide enough ventilation in most situations to move a hive. The entrance on colonies with screened bottoms can be closed completely with a strip of wood and moved. Exceptions would be on very hot days. Use the following methods to move colonies on hot days or colonies with a solid bottom.

Remove the inner cover and nail a screened cooling board over the top to close and ventilate the top of the hive. A cooling board is a plywood panel the size of an inner cover with a large, centrally located, screened window. An inner cover with the center hole screened can be used for a short distance move. In cool weather, a cooling board may not be necessary.

To screen the entrance for a short-distance move, plastic window screen may be stapled across the entrance. For longer distances, an entrance screen can be made by constructing a frame with 1- to 1/2-inch by 1/2-inch pieces of wood that will fit between the bottom board cleats, against the front of the hive body to cover the entrance. The bottom of the frame is made with a 3/4-inch piece to cover without blocking the entrance. The frame is covered with metal window screen wire. The screened frame encloses a screened porch on the front of the hive. Air will circulate through the entrance and out the top to keep the bees cool in transit. Robbing screens are similar and commercially available. They usually can completely close, which would be useful in transit.

Once the colonies are loaded, if using an open bed truck or trailer, the colonies should be covered with bee netting to prevent any bees from escaping that might find their way out of the hive. Hives can shift during transport releasing bees. Nursery shade cloth or similar fine mesh screen can be used. Colonies in closed bed trucks may overheat on hot days due to lack of air flow.



Figure 37. Entrance screen for moving bees.

### **When to Move a Colony**

Moving at nighttime is best, because all the field bees should be in the colony. A daytime move, especially a long-distance one, would result in the loss of foraging bees returning to the old location. The last bees to return to the hive will arrive at dusk. Have everything in place except the entrance screen. Attach the entrance screen with two wood screws through the two end bars and load the colony for moving to a new location.

Place the colony on a base at the new location. Smoke the entrance and remove the screen. Place the inner and outer covers on the hive.

### **Removing Surplus Honey**

The bees will fill the combs and cap the honey when they have cured it to approximately 18 percent or less water. Some of the frames of honey may not be capped until several days after the nectar flow has stopped. This is because the bees may be adding additional nectar to the cells or they still may be drying the honey down to 18 percent or less water. The frames and supers of honey that are capped can be removed from the colony. Use caution when harvesting honey in uncapped cells. It is often too high in moisture content and will ferment in storage without additional drying. However, if trying to extract honey before the flow is completely over, uncapped frames of honey that are 18 percent or less water may be encountered frequently. To check if uncapped honey is suitable for extraction, take the frame and shake it on its side so that nectar can come out of the cells (not towards the bottom or top of the frame). If wet nectar comes out it is too wet to extract. If the honey stays in the cells, it is usually dry enough to extract. A relatively

inexpensive honey refractometer can be used to test the percent water in the field or the honey house to make sure.

Extract soon after removing supers from the hive. Honey must be extracted within three to four days after removal from the hive to prevent damage by wax moths or small hive beetles. Be prepared to extract the honey when you remove the super from the hive. If extraction is not possible within three or four days, frames of honey can be stored below 32 degrees F for long periods of time without danger of crystallization. However, they must be rewarmed to be able to extract.

Open the colony and inspect the supers of honey. Frames of capped and uncapped honey can be exchanged between supers. The super of honey may contain many bees. Do not use smoke to drive the bees out of the super; excessive use of smoke may taint the flavor of the honey.

### **Methods to Remove Bees from Honey Supers**

To harvest a small amount of honey, you simply can use a bee brush to remove bees from individual frames. On the ground near the colony, place an empty super inside an outer cover turned bottom side up. An inner cover with the hole taped shut, a flat piece of plywood or an outer cover is needed to cover the super as you place the frames of honey that are free of bees into the super. Remove a frame of honey from the super of honey taken from the colony. Hold the frame by an end bar a short distance above the entrance. Use a bee brush to brush the bees off. You should 'flick' the bees off with the brush, not drag the brush over the backs of the bees making them angry. Immediately place the frame into the empty super and cover the super to prevent the bees from returning to the frame. Brush the bees from the remaining frames and load the super, keeping it completely covered except to insert the frames of honey. This method can be used very effectively with a small number of colonies. To remove bees from entire supers, you can use a bee repellent and/or a blower.

### ***Bee Repellants***

A repellent, such as Fisher's Bee Quick, a natural, nontoxic blend of oils and herbal extracts (**not** to be confused with Bee-Go) is sprayed in generous quantities onto a fume board, which is placed on the

top of supers. As the repellent evaporates, the odor will drive the bees out of the super within minutes. The fume board consists of an absorbent cloth or pad stapled onto a wooden frame or spare inner cover. The cloth side is placed on top of the super. Warming an outer cover for a few minutes in the sun before covering the fume board will accelerate the process.

### ***Air Blowers***

Blowers may be purchased from beekeeping supply vendors to remove bees from honey supers. Or, you can use a leaf blower made for home and garden use. A super must be held upright on its side while air is blown between the frames. Bees may be difficult to dislodge. Also, the noise and smell of the blower may irritate bees and make them more defensive. A common practice is to use a repellent first then use a blower to remove the few remaining bees.

### ***Bee Escapes***

Escapes provide a more passive method of bee removal. Bee escapes fit into the center hole of an inner cover to allow bees to exit a super, but not to re-enter it. The inner cover with bee escape is placed between the honey supers and the brood nest. This method works best on cool nights when bees move down to the brood nest. Escapes usually must be left on colonies for at least two days to ensure all or most bees have been removed. However, this practice has fallen out of favor in Tennessee. Since escapes leave supers of honey unprotected by bees for multiple days, the small hive beetle can quickly move in and begin destroying the honey.

### ***If You Find Brood in Honey Supers***

A queen may expand the brood nest up into the honey supers. Check all supers of honey to be removed for presence of brood. This situation normally can be avoided by using queen excluders when supering hives. If brood is present, locate the queen and return her to the brood nest below. Place a queen excluder over the hive bodies containing brood to prevent the queen from re-entering honey supers. The honey supers can then be extracted after the brood has hatched out, 21 days later if eggs were present.

## Avoid Robbing

Keep all frames and supers of honey sealed during honey removal. During removal, stack supers filled with honey between outer covers on top and bottom to prevent robbing bees and other insects from reaching the honey. For transport, honey supers should be well secured. Locking straps work well for transporting supers.

## Overwintering a Honeybee Colony

### Prepare the Colony

A colony of honeybees will overwinter well when you prepare them for winter conditions. The colony must have enough bees to cover five or more deep brood frames or eight or more medium brood frames. Smaller colonies may have difficulty surviving the winter. To ensure a colony enters the winter with enough bees, requeen in August. A young, prolific queen introduced into the colony in August lays a large number of eggs during September and October. Make sure mite treatments have been made, if needed, in August. You want large numbers of young healthy bees that emerge without mite damage to maintain the colony through the winter.

### Provide Adequate Honey for Survival

Once the main honey flow for honey production is over, usually mid- to late August at the latest in higher elevations, it is good to reduce the size of the hive to the size for overwintering. Leaving large amounts of unused comb on a hive can encourage small hive beetle problems, which naturally increase by August. Common overwintering configurations in Tennessee are two deeps, three mediums, a deep and a medium, or a deep and a shallow. A colony can be overwintered in smaller hives — for example, one deep hive body or two medium hive bodies — but they will likely require extra feed late in fall and early in spring to survive. To survive the winter, each colony should contain at least 40 to 50 pounds of honey. Most of the honey should be stored in a second brood chamber or in supers above the brood chamber, although some may be in frames holding, or adjacent to, the brood. To help you estimate the amount of honey a colony contains, remember that a shallow hive body filled with honey weighs approximately 35 pounds, a medium hive body weighs approximately 45 pounds, and a deep hive body weighs 60 to 75 pounds.

## Minimize Inspections in Cold Weather

Before cold weather arrives, check the brood chamber for a laying queen and healthy brood. If the colony must be opened in cool weather, this should be done when the temperature is at least 55 degrees F. Brood frames should not be exposed to the cold.

### Ventilate If Needed

Colonies can be ventilated to remove excess moisture during the winter months. Inner covers with an additional opening that provides ventilation and a second exit can be purchased. A twig can be placed between the inner and outer cover to provide an additional ventilation space, but this space should be less than what other, robbing bees can enter.

### Reduce Air Flow If Needed

To reduce airflow and further protect the colony, an entrance reducer can be inserted during times of extreme cold weather. This reducer usually is not necessary for most of Tennessee. Also, screen bottom boards should be blocked with a piece of thin wood or similar material for colonies exposed to high winds. However, many beekeepers in Tennessee keep their screens opened year-round for added ventilation.

## Pests of Honeybees

### An ounce of prevention is worth a pound of cure.

Like any creature, the honeybee is beset by a number of pests and pathogens. There are a variety of ways to deal with these problems. We advocate an integrated approach. Both proper cultural techniques (to prevent problems from occurring) and hive monitoring (to determine whether treatment is necessary) should be employed concurrently. Chemical treatment should only be used as a last resort. This approach benefits the beekeeper not only because chemical control is expensive, but also because sustained use of antibiotics or pesticides may create resistance reducing the efficacy of these treatments when you really need them. Additionally some in-hive acaricides will absorb into the comb, contaminating them and causing low level stress on the colony.

## **Culling comb**

Although comb is valuable, periodic removal of old comb is important to maintain colony health. Many pesticides are wax soluble (including coumaphos and fluvalinate, popular treatments for varroa) so they can be absorbed by comb and may have subtle deleterious effects. Additionally certain pesticides interact with one another to produce much greater rates of mortality than either alone. So, even if only low levels of pesticides are present in the comb, they can cause mortality or possibly exacerbate other problems. Finally pathogens like *Nosema*, bacteria, and viruses can accumulate in old comb causing further stress. A general rule of thumb is that comb should be recycled every five years (two frames per box per year). It's helpful to date the frames as you make them so you can keep track of their age.

## **Monitoring for Disease**

It's very important to monitor the health of a hive so you can mitigate problems before they become serious and treat if needed. You should be able to identify the symptoms of disease when working a beehive, which will enable you to intervene before the colony moves beyond help.

**Brood appearance** — The brood is a particularly important place to direct your attention not just to identify disease presence but also to ascertain colony health in general. The presence of healthy brood is one of the most important indicators of a healthy beehive. You should examine all stages of larvae, as well as capped brood and eggs. If all of these components look good, you know the hive is queenright and free of a number of brood diseases like European foulbrood, American foulbrood, chalk brood, sacbrood and stonebrood. Additionally, high levels of mites can cause abnormal brood appearance (See parasitic mite syndrome.) so healthy looking brood is important to see.

Healthy brood comb should have a solid and dense roughly circular pattern. Nearly every cell should be filled with an egg, larvae or capped pupae within this circular (or semicircular) brood area. Typically larvae of a certain age are grouped together. Cappings of pupae should be a consistent color and slightly bowed outward.

In contrast diseased brood will not appear in a solid or consistent pattern and will seem more scattered throughout the frame. Cappings may be

sunken or perforated and a dark greasy brown. Frequently ages of brood will be intermingled as the queen struggles to replace diseased brood removed by workers.

**Adult bees** also may display symptoms of pest of disease affliction. Bees unable to fly, bees with unhooked rear wings, visible presence of varroa mites, or dysentery (streaking along the front of the hive; more rare in recent years) may all indicate the presence or disease or pest issues within the colony.

Finally, smell can be important when monitoring for disease. European foulbrood and especially American foulbrood produce a sour odor. However strange smells don't necessarily mean disease. Fermented syrup in a feeder can smell bad or the bees may be foraging nectar with a strong odor like goldenrod.

## **Tracheal mite, *Acarapis woodi***

Tracheal mites have spread throughout Tennessee since their introduction in 1987. In past years, this parasite is believed responsible for 50 percent of the losses of bee colonies statewide, with local losses reaching 100 percent. The mite had become a severe problem, in part due to the difficulty in detecting the minute parasite and the ease with which contaminated bees can spread the mites. The mites are spread among colonies by drifting bees or among apiaries by any activities of beekeepers involved in moving adult bees. Other sources of contaminated bees include bee swarms and from package and queen bee producers.

Recently the tracheal mite has become a less common problem, possibly because extremely high initial losses culled out susceptible genetics leaving only bees resistant to the mite. It's also possible that varroa mite treatments have reduced tracheal mite populations to very low levels.

## **Biology**

The oblong mites are microscopic, averaging 160 microns long by 75 microns wide, about 1.5 times as long and 0.75 times wide as the diameter of a human hair (100 microns = 1/250 inches) [Fig., Morse, Gleanings in Bee Culture, January 1991, pg. 27]. They live and breed inside the trachea or breathing tubes of the bee, especially in the large tubes in the prothoracic region. The mite penetrates the tracheal wall with its piercing mouthparts and feeds on hemolymph (bee blood). The effects of feeding, opening the tracheal surface to pathogens, and the reduced capacity of air

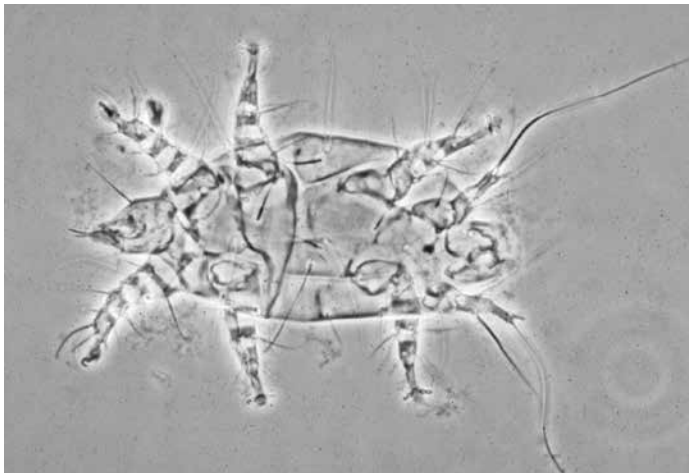

Figure 38. Adult tracheal mite.

flow to the wing muscles are the suspected damaging factors that kill bees.

### Symptoms

The wings of infested bees are often unhooked, with one wing projecting 90 degrees from the axis of the body. These bees (crawlers) are unable to fly and crawl about the hive entrance. Numerous bees have been observed on occasion to crawl out of the colony and die.

Population levels of mites are usually highest early in spring when bee population levels are low. As bees cluster in winter, the mite population builds up in the old bees and as brood rearing commences, mites move to young bees. If the wintering colony is weak due to food shortage or disease, the effect of mites is increased. Mite populations are lowest during summer when bee populations are high.

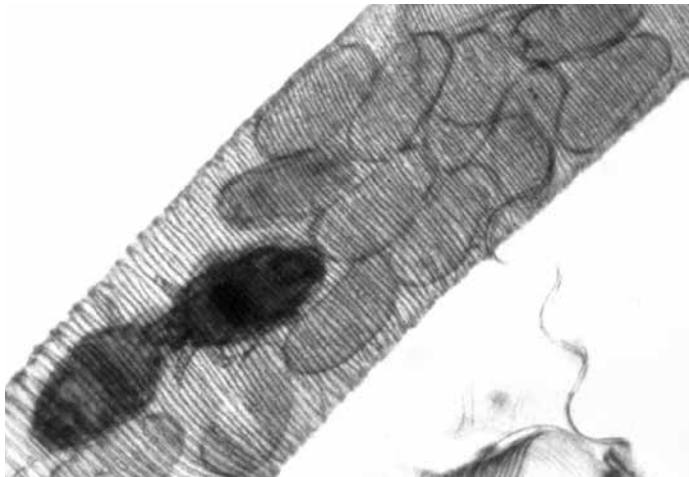

Figure 39. Adult tracheal mites and eggs in the breathing tube of a bee.

### Varroa mites, *Varroa destructor*

The varroa mite, *Varroa destructor*, was discovered in Tennessee in November 1990. This infestation originated from contaminated honeybee queens and packages of bees shipped from producers in South Georgia to beekeepers in more than 50 Tennessee counties. Currently, varroa mites are found throughout Tennessee. After being discovered in 1987 in Wisconsin and Florida, they spread rapidly throughout North America. Varroa mites have a worldwide distribution, and are found on all continents where bees are kept.

This parasite is so damaging because only recently has it come into contact with a new host, the European honeybee [*Apis mellifera* L. (EHB)]. The EHB has limited natural defenses to this parasite. The original host, the Asian honeybee (*A. cerana*), has established an "equilibrium" with its parasite because, among other factors, it can physically remove mites and kill them.

The varroa mite is currently the single most destructive problem affecting honeybees in North America. Monitoring is crucial and treatment is necessary for most colonies, most years. (See <http://bees.tennessee.edu/ipm.htm>.)

### Economic Damage

This lethal, pinhead-sized parasite is causing severe economic loss by killing thousands of honeybee colonies annually. At the time of its initial appearance, severe losses (in some locations of 100 percent) were attributed to this mite. Even two decades after its introduction, the varroa mite continues to be the single most common cause of colony death in Tennessee.

Losses of bee colonies in Tennessee are believed to be affecting pollination of vegetable and orchard crops. Reductions in crop yields are suspected to be related to reduced numbers of pollinators. Varroa mites increase the costs and risks associated with beekeeping and therefore increase the cost of pollination contracts between crop growers and beekeepers.

## Biology

The varroa mite is an external parasite of honeybee larvae, pupae and adults. The infestation starts when a pregnant female mite enters the colony, attached to a returning bee. The adult female mite is oval (ca 1.2 X 1.6 mm), brown, with eight legs and is about the size of a pinhead. She searches for a larva with preference for drones over workers and crawls into the cell in the comb containing the larva. The cell is then capped over by workers. The female mite lays eggs that hatch and begin to feed on the bee larva.

Daughter mites develop in the cell from each mother mite and mate, inside the cell, with a male produced by their mother or another invading mite. These males do not survive outside the cell. In the 12 days that a worker cell is capped, an average of 1.45 daughter mites reach maturity. In drone cells, the capped stage is longer at about 14 days. During this

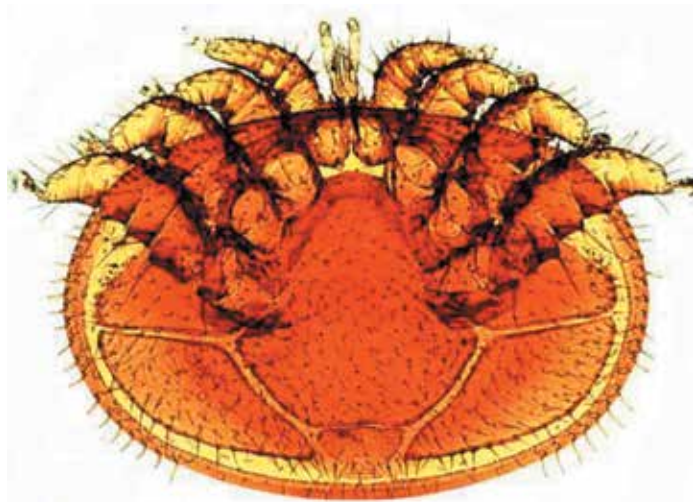

Figure 40. Adult female varroa mite

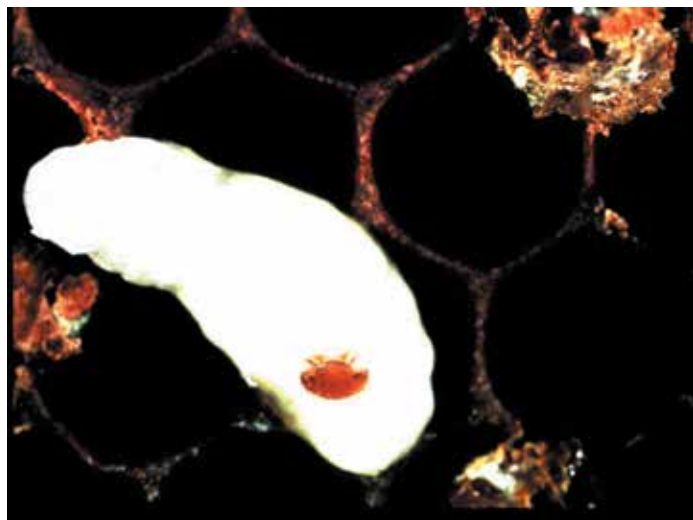

Figure 41. Varroa mite on honey bee larvae

time 2-2.2 daughter mites can reach maturity. The longevity of the adult mite varies greatly and is longer lived during the winter season. Although mites in the lab can have up to seven reproductive cycles, it is thought that the average number of times the mite can reproduce is greater than 1.5 but less than two.

Varroa mites literally suck the life out of the host bee by penetrating its internal membranes with their mouthparts and withdrawing fluids. The puncture wounds can become the entry points for disease organisms. A high level of parasitism by varroa mites exacerbates several diseases, including viruses and European foulbrood, and can be described as Parasitic Mite Syndrome (PMS) when this interaction occurs.

Bees that emerge after being parasitized by a single female and her offspring have a shorter life span than do nonparasitized bees. Bees parasitized by more than two mites may die before emerging, or if they do emerge, they weigh less, may appear deformed and seldom leave the colony. The number of bees in the colony diminishes steadily as the number of mites increases. Fewer nurse bees are produced to feed the brood, and brood production ceases. At this stage, the entire colony collapses. All remaining adults usually leave the colony at one time, with each bee carrying numerous mites. These heavily infested bees often fly into nearby colonies and transfer mites in the process.

The total collapse of a colony usually comes as a complete shock to the beekeeper. One day the colony appears "strong" (many bees), and two weeks later, the colony is dead, without a single live bee present.

Mites can be dispersed quickly whenever infested bees come in contact with uninfested ones. This dispersion can happen easily when infested bees (especially drones) drift (enter a colony that is not their own) into an uninfested colony, or during robbing, as uninfested bees remove honey from a colony occupied by infested bees.

## Detection

Several methods can be used to detect varroa mites: (Please see Sensitivity of Method.)

- Observing pupae is the first method. Examine pupae for mites by uncapping the cells, extracting the pearly white pupae, and looking for the dark brown mites adhering to the surface. Use a capping





Figure 42. Removing a sticky board.

scratcher or table fork to uncap several cells at a time, and spear the pupae beneath. A pair of tweezers also can be used to extract a single pupa from its cell. Select pupae with pigmented eyes, because these can be extracted from the cell without breaking apart. Select drone pupae if they are present, because varroa prefer drones. If drone pupae are unavailable, then look at worker pupae. Sample at least 25 drone or 50 worker pupae to determine infestation level.

- A sticky board trap (Tennessee trap) is used to sample a whole colony for mites. A sticky board trap is placed on the bottom board inside the entrance of the bee colony. The board can be used alone or in combination with a treatment to detect mites. Mites die from natural causes, fall off the bees, and land on the sticky board. A sticky board is made using stiff cardboard with a smooth, light-colored surface that is cut to fit inside the hive. A sticky substance such as Tanglefoot, clear “contact” shelving paper or spray cooking oil is applied to the upper surface to catch and hold mites. A metal screen made from eight-mesh (per inch) hardware cloth (same dimensions as the sticky board) is placed above the board, to prevent bees from removing the mites, and from becoming trapped on the board. Paper boards coated with sticky material can be purchased from beekeeping suppliers. The sticky board must be examined within two or three days, because other natural debris in the beehive will accumulate on the board, making it difficult to distinguish mites from debris.

- The powdered sugar shake method is used most often because it is quick and easy to perform. All that is needed is a sample of bees, powdered sugar and a screw-top glass jar with the lid replaced with eight-mesh per inch hardware cloth. (Alternately, ether starting fluid can be substituted for powdered sugar but this will kill the bees. If ether is used, spray two quick shots of starting fluid, then roll the jar. The mites will stick to the outside of the jar.) This technique is not as sensitive as some other methods (see Sensitivity of Method). Select a brood frame with worker bees on it. Make sure the queen is not on this frame because the bees will be sacrificed. Shake 300 bees (about ½ cup) from the frame into a quart jar. A funnel may aid in this transfer. A temporary funnel can be made using a rolled up piece of paper or a plastic gallon container. Cut the plastic container in half, insert the “mouth” of the container (it becomes the spout of the funnel) into the sample jar. Instead of shaking the bees off the frame, dragging the jar top rim backwards across the frame can cause them to dislodge and fall in the jar. Pour a few tablespoons of powdered sugar into the jar with bees, cap the jar and shake vigorously. Be sure to entirely coat the bees with powdered sugar. Wait one minute, then shake the jar over a white piece of paper. The powdered sugar and mites will fall through the hardware cloth where they can be counted. The bees can be dumped at the hive entrance. Be careful not to confuse wax scales produced by the bees, or lumps of pollen, with varroa. Wax scales are white. Probe any dark objects of similar size to varroa. Pollen lumps are soft and will break apart when probed.
- An alcohol shake is a method used in the laboratory to more closely examine a sample. A sample is collected as mentioned above for ether roll. Add several ounces of 70 percent rubbing alcohol (isopropyl) to the sample. Place the sample jar into a laboratory shaker and shake for 30 minutes. Pour the bees and liquid through a coarse (60-mesh) soil sieve that is suspended above a vacuum filtration funnel. The bees are collected on the sieve screen; the liquid passes through the filter; and debris, including mites, is collected onto a piece of filter paper. Mites are easily observed, if present, on the white background of the filter paper. If necessary, a magnifying hand lens or microscope can be used to confirm the presence of mites.

## **Sensitivity of Method**

Observing pupae is the only method that examines mites when they are present in the brood. Varroa spend 80 percent of their life in brood and only 20 percent outside on adult bees. A brood frame with a standard semicircle pattern of capped brood (both sides) has approximately 5,000 cells. Therefore, three full frames of capped brood may contain 15,000 pupae. If you find 10 mites in 100 cells (10 percent) you may have 1,500 mites in the brood. If there are another 20 percent in the adult bees, then there are 1,875 mites in the whole colony. These figures are a crude estimate only because the amount of brood varies seasonally and with the health of the colony. When there is less capped brood, you may find more varroa per cell.

Methods, such as the powdered sugar shake or ether roll, that examine a small sample (300) from a colony of 30,000 are not very sensitive. These methods sample only 1 percent of the adult bees in the colony. Multiply the number of mites found in the jar by 500 to estimate the total number in the colony (including brood). This test may not detect the mites if they are present in low numbers. However, both methods are easy to perform and results are available immediately, allowing the beekeeper to start treatments, if needed. If an ether roll or sugar shake reveal mites in a single colony in an apiary, additional tests may be used to discover a low infestation in other colonies.

The sticky board test is more sensitive than the ether roll, because it samples the entire adult population at one time. However, this test is more involved, it requires the hive to be manipulated to install the trap, and requires a return visit one or two days later, before mites can be discovered. The number of mites on the board should be multiplied by five to provide a crude estimate of the total mite population in the colony, since varroa spend so little of their time on adult bees. It is also important to consider the population of bees in the colony with this test. Colonies with more bees will drop more mites.

## **Treatments**

For many years Apistan and CheckMite+ have been widely used miticides in the United States. Apistan consists of a pyrethroid chemical, fluvalinate, impregnated in plastic strips. CheckMite+ contains coumaphos, an organophosphate, similarly

impregnated in plastic. Although these treatments have been effective in reducing mite levels, mite resistance to these compounds is now common. Additionally both Apistan and Checkmite leach into wax and can interact with other pesticides found in the environment; therefore, we recommend other options for treatment. Apistan and Checkmite also can interact with each other, making them many more times toxic to bees than the products used alone. Never use these two chemicals together. A new product, Apivar, containing the formamidine acaricide, amitraz is available now as a plastic strip. We suspect that mite resistance to this chemical will occur in a couple years.

**Formic acid** is a chemical that has been used in various mite control products for over a decade. Formic acid occurs in nature and can be found in honey from colonies never treated with formic acid. **Formic acid products are highly caustic**, so take care in handling it. Beekeepers have sustained serious chemical burns when attempting to make homemade formic acid treatments. In addition, beekeepers who do not follow product instructions have overdosed and killed their bees. Use only the labeled products, currently MAQS or Mite Away Quick Strip, and follow the instructions. The treatment period is sensitive to temperature, and colonies need a minimum population since brood rearing is negatively affected to some degree.

**Oxalic Acid** is one of the newest treatment methods for Varroa mites and was approved for use in beehives in 2015. Oxalic acid, when used according to label directions, is a very effective miticide and will not harm the honey bee colony when delivered correctly. Studies conducted on oxalic acid's efficacy indicate that it is 90-99 percent effective at killing mites with limited damage to the bees and brood within the colony. Even though oxalic acid treatments may be very effective at killing Varroa mites, it is not effective against mites that are under brood cappings. The timing of oxalic acid applications is critical to mite population knock-down. It is suggested that treatments occur when there is little brood present, such as late fall, early spring, a caught swarm, packaged bees, or after completing a split without brood frames. Early morning or evening are the preferred times of the day to treat, as the highest population of bees will be present in the beehive. As with formic acid treatments, oxalic acid requires the use of personal protection equipment to apply, because oxalic acid can be absorbed through skin and the vapors are harmful. Oxalic acid is rated as **Category 1**

for toxicity, so proper health and safety precautions must be used. Mandatory safety equipment includes gloves, splash goggles, synthetic apron and a vapor/dust respirator as vapors produced during treatment can contain carbon monoxide.

Oxalic acid treatments may be applied in three ways. The first method is the most effective and involves vaporizing oxalic acid crystals with heat in the beehive. A vaporizing pan tool is loaded with the recommended amount of oxalic acid and then placed 0.5 to 0.75 inch within the beehive, and the entrance is sealed with a damp rag to prevent vapor loss. The vaporizer is connected to a 12 volt, 15 amp battery to supply current which turns on the element that heats the pan to vaporize the oxalic acid crystals. The current is supplied to the vaporizer for two and a half minutes and then disconnected. The vaporizer is then left in the colony for an additional two minutes to fully release the vapors into the hive.

Additional treatment techniques include spray misting and trickle. Spray misting can be applied directly to the bees and is especially useful for treating captured swarms and packaged bees. Spray mists are applied an hour after spraying the bees with a 1:1 sugar water solution to fill their honey stomachs and reduce ingestion of the oxalic acid spray. The trickle method involves mixing the oxalic acid with a warm 1:1 sugar water solution which is then trickled with an eyedropper or syringe between the frames and onto the bees. Five mL of solution should be administered at a time, and a total of 50 mL of solution should be used per colony.

Although oxalic acid has been shown to not accumulate in brood comb, honey supers should be removed prior to treatment as honey and pollen stores will become contaminated with the vapor. As with all pesticides, caution should be exercised and all product label instructions and safety precautions followed. Oxalic acid and vaporizers may be purchased through Brushy Mountain Bee Farm and from several other online resources.

**HopGuard II** is a newly improved Varroa mite treatment product. It is produced from natural compounds found in the hops plant and has been shown to help reduce the level of Varroa mites in bee colonies. This product comes as cardboard strips that have been impregnated with liquid soaked potassium salt of hop beta acid. These infused strips are hung in between the brood frames and left in place for a month. The recommended rate of application is

one strip for every five frames that are covered with bees in the brood chamber, or two strips for every 10 frames that are covered with bees. HopGuard II strips are only to be used in the brood chamber as the odorous hops extract may contaminate the wax and honey in supers, rendering the honey stores unusable. An advantage to using HopGuard II for treatment of Varroa mites is that it may be used without removing honey supers, **as long as the strips are not used on the honey supers**. Colonies may be treated up to three times per year; any further treatments may harm the health of the colony. Best results may be achieved by treating when the colony is broodless, as Varroa mites breeding in capped brood cells are less likely to be affected by treatment. Treatment with HopGuard II strips requires the applicator to wear chemical-resistant gloves while handling the strips to avoid dermal irritation. Safety glasses or goggles should also be worn as HopGuard II may irritate the eyes. As with all pesticides, label instructions and precautions must be followed to ensure proper treatment and safety to bees and applicators.

**Thymol based treatments** — Apiguard and Apilife VAR are two thymol based varroacides. Thymol is considered a soft treatment because it's natural (derived from the thyme plant). However, just because it is a soft treatment does not mean it is totally benign. Apiguard gel can cause skin irritation or permanent eye damage in humans, and both Apiguard and Apilife VAR may cause the queen to suspend brood production. However, these products are preferred because bees may be less likely to develop resistance to thymol-based products due to its more generalized mode of action. The same is true of formic acid. Although thymol is a food additive (you may notice a "mouthwashy" smell to Apiguard) these products should be removed at least two weeks prior to a honey flow to prevent the flavor from tainting the honey.

## Pesticide caution

Fluvalinate (Apistan), coumaphos (CheckMite) and amitraz (Apivar) can cause health risks by being absorbed in honey and beeswax if not applied according to the label directions. The treatment should not be applied during a honey flow or when supers of honey are present. Please read the label and follow instructions closely.

## Other Pests

Honeybees share their environment with many other opportunist predators and scavengers that cause little harm to a colony but can sometimes be found abundant in weak colonies. Yellow jackets are commonly seen prowling around the front of hives in late summer looking for recently dead bees to carry off. Below is a photo of a robber fly (Asilide) that has just caught a worker bee.

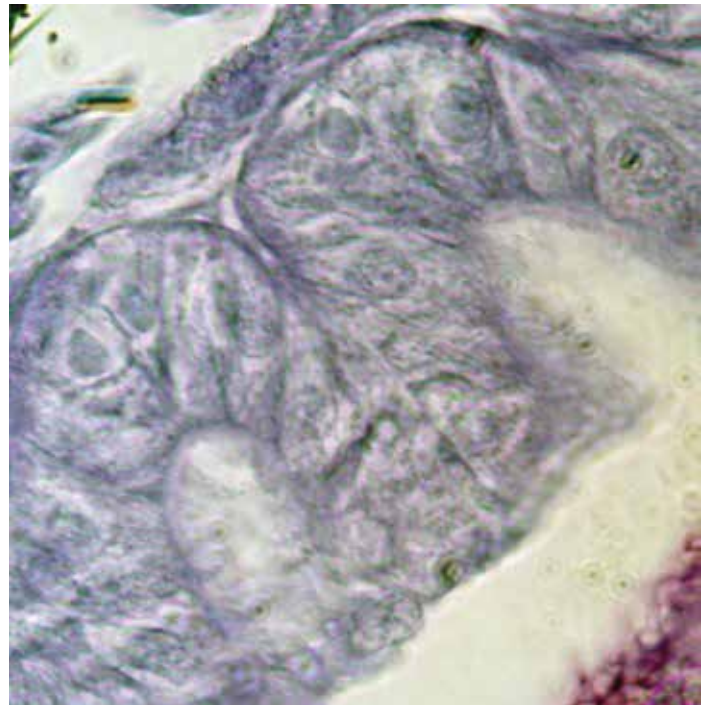

Figure 43. Mid-gut epithelial cells of a honeybee worker.

## Nosema

Nosema disease has been a problem for beekeepers for more than 100 years. *Nosema* species are classified as microsporidians. Microsporidians are single-celled parasites related to fungi. Microsporidia are considered obligate parasites; only the spore (a dormant stage) can live outside the host. However, these spores are very resistant and can persist for many years in the environment. Until recently, the only species known to infect honeybees was *Nosema apis*. In 1996, *Nosema ceranae* was found infecting the Asian honeybee. *Nosema ceranae* has since been found throughout the world and is now more common than *N. apis* in North America. The introduction of this new species has made management more difficult

because *N. ceranae* infected bees may display no obvious symptoms, like streaking, and this species may be more virulent.

Bees are infected after ingesting *Nosema* spores. This infection can happen when a house bee cleans a bit of comb that has been contaminated with infected feces. These spores then germinate in the gut and invade one of the cells lining the midgut. They rob nutrients from the cell and reproduce by dividing. The parasite will continue to reproduce until the cell becomes exhausted, eventually rupturing and spilling the new spores into the gut. These spores may

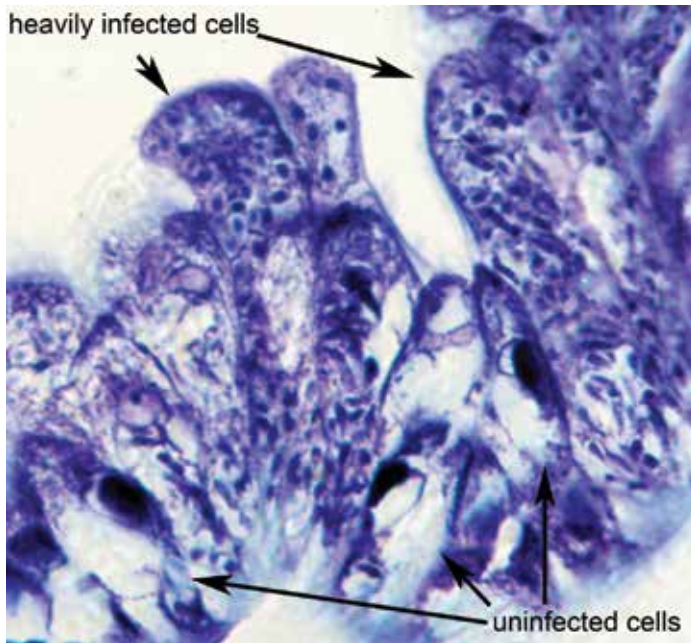

Figure 44. Honeybee mid-gut showing infected and noninfected cells.

germinate immediately, infecting other cells, or they may be expelled with the feces

### Diagnosis

*Nosema apis* was relatively easy to diagnose due to the presence of fecal spotting on the front of the hive. Bees infected with *N. ceranae*, the more common pathogen today, don't exhibit this symptom so more direct diagnosis is necessary. (Example of direct diagnosis at <http://www.extension.org/pages/25556/testing-for-nosema-spores>.) This diagnosis will require a 400x microscope, slides for the microscope and items you should be able to find in your kitchen. To sample for *Nosema*, older field bees should be collected from in front of the hive in good weather. Older bees are needed because young infected bees will have few developed spores. You can use a bee vac or you can block the front of the hive with the inner cover and snatch bees out of the air with a small hand net. You'll want 25-50 bees. Place all bees in a mortar, a bowl or a zipper seal plastic bag. Then measure 1 mL water for each bee sampled (a large syringe works well). Place a small amount of water into the mortar, bowl or plastic bag. Using a pestle, spoon or rolling pin (for use with mortar, bowl or plastic bag respectively), crush the bees thoroughly. Add the remainder of the water to bring level to one mL per bee. Stir this mixture really well and place a drop onto a microscope slide. Apply a cover slip and wait 60 seconds for the spores to

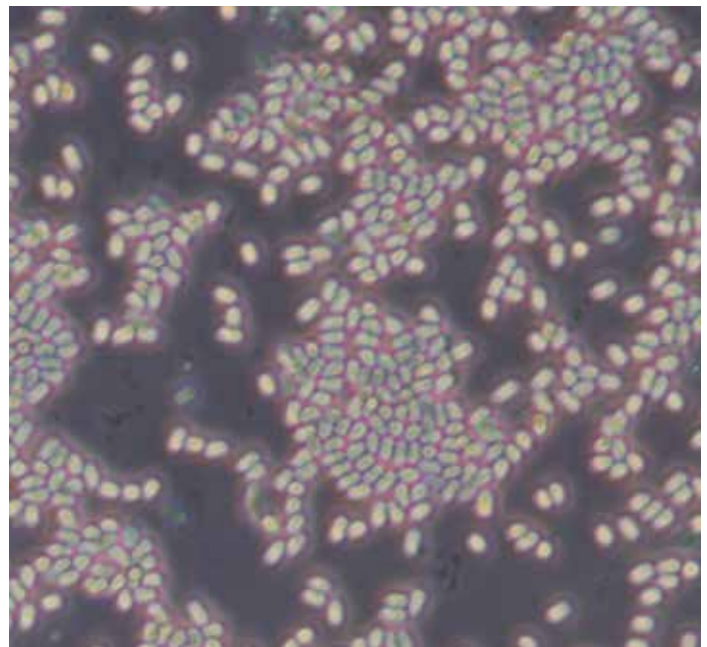

Figure 45. *Nosema* spores at 400x.

settle. If present the spores will be visible as small, consistently smooth-sided ovals. There is no well-defined threshold for treatment of *Nosema* at this time. This method will tell you if your colonies are infected or not and if spores are abundant or sparse. You'll need to decide if treatment is warranted based on your personal techniques and climate. Generally if you see 20 or more spores in the field of view at 400 times magnification, treatment may be necessary.

### The Small Hive Beetle

A new pest of honeybees was found in Tennessee in 2000 when a beekeeper discovered beetles damaging beehives. The beetles were identified as *Aethina tumida* Murray, the small hive beetle, a pest from South Africa. The adults are 6 mm (1/4 inch) long, dark brown to black, flattened, oval to oblong, with the head often "tucked" below the thorax. If the head is in view, the short antennae have a conspicuous club on the last segment. The larvae are elongate, whitish grubs, tapered at front and rear ends, which under magnification have rows of spines on the dorsum. Adults and larvae inhabit beehives, where they feed on larvae, stored honey and pollen. As they feed, the brood and honeycombs are damaged, especially as the beetle larvae burrow through it. As the infestation increases, the honey ferments and bubbles out of the cells. Brood rearing stops when beetle numbers are high. Honeybees have been observed to abandon colonies infested by the beetles. As the infestation

builds, fermented honey is observed to run out of the hive; this is often the first external symptom that is noticed. Pupae of the beetles are white to brown and can be found in the soil beneath and near the hive. The development of the beetle from egg to adult in South Africa requires 38 to 81 days, with five generations possible during warm months.

Small hive beetles are most likely to be found in colonies that have been weakened by something else, usually mites. Larvae congregate in corners, possibly to cluster together to retain heat. This clustering distinguishes the beetle larvae from wax moth larvae that are found scattered throughout weak colonies. Hive beetle larvae make a slime as they feed. This slime acts as a repellent to the bees. When the larvae become numerous, the slime is believed to cause the bees to leave the hive. Honeybees will not re-enter "slimy" comb. The slime must be washed off with water.

Hive beetles will be noticed especially between the inner cover and top, but also will be noticed in other areas of the hive. Presence of the adults is considered normal while presence of larvae indicates a problem may be imminent. Do not store honey in comb for long periods, especially if pollen is present. Beetles can begin destroying unprotected combs in a number of days. Also, you should be careful about stacking weak colonies and extracted supers onto other colonies. Freezing combs will kill *A. tumida* eggs, larvae and adults.

## American Foulbrood

American foulbrood is a disease of honeybee brood caused by the bacterium *Paenobacillus larvae*. Symptoms of the disease include a spotty brood pattern; concave, punctured capped brood cells; discolored larvae; dried, shrunken brood (called scales) stuck tightly onto the bottom of cells; and an unpleasant odor. This disease affects the capped stage of brood and cappings will need to be removed to examine larvae. Pearly white larvae turn chocolate brown and melt into the bottom of the cell. In some cases the pupal tongue may protrude out of the remnants of the larvae to the top of the cell.

The disease is spread by long-lived, hardy spores transmitted by bees, on beekeeping equipment, in honey and in other ways.

Because of the persistence of spores and the devastating effects of the disease, the recommended

action for American foulbrood is burning of the infested colony, including bees and woodenware. It is a law in Tennessee that hives infected with American foulbrood are to be reported to the Tennessee State Apiarist. Control should be coordinated with the Tennessee State Apiarist. Once an infestation is detected, the bees in the affected colony should be killed (one way to do this is by spraying ether starter fluid in the entrance). Plug the entrance, then burn the entire colony in a hole in the ground. After burning, the remains should be covered with soil. Tools coming into contact with the hive should be sterilized. Bleach does not sterilize American foulbrood because it cannot penetrate the spore cell wall.

American foulbrood can be suppressed with treatments of the antibiotic terramycin. Unfortunately, this practice has led to resistant strains of American Foulbrood and should no longer be used. Some sources recommend treatment with terramycin *after AFB symptoms have been observed* to suppress the disease. Although legal and apparently effective, it is an irresponsible practice that will ultimately spread the disease to neighboring beekeepers. Treatment with antibiotics will stop symptoms within the hive but will not destroy spores. AFB spores are extremely persistent, and so once begun treatment must continue indefinitely. Also, if the hive dies and is robbed by bees not receiving antibiotic treatment AFB will appear in those hives. Since American Foulbrood is such a devastating disease and so easily spread, we do not recommend treatment with terramycin for AFB. Severe infections of European foulbrood can be mistaken for American foulbrood.

## European Foulbrood

European foulbrood, or EFB, is a bacterial disease that affects honeybee larvae before the capped stage. European foulbrood disease is characterized by dead and dying larvae which can appear curled upwards, brown or yellow, melted, or dried out and rubbery. The causative bacterium, *Melissococcus plutonius*, is ingested by honeybee larvae after which the bacterium competes for food inside the larvae. If the bacterium outcompetes the larva, the larva will die before the cell is capped. Alternatively, the bee may survive until adulthood if the larva has sufficient food resources. European foulbrood should not be confused with American foulbrood, or AFB, which is caused by a different bacterium that produces different symptoms and control requirements.

## AFB VS. EFB

It is important to not confuse European foulbrood with American foulbrood. These two very different diseases require different management and treatment routines. Both, however, are bacterial brood diseases. Use the table below as an overview to learn the difference between European foulbrood and American foulbrood.

A “spotty brood pattern” in a honeybee colony can often be the first sign of a wide variety of problems, including EFB. A spotty brood pattern can occur when some larvae die in their cells from a disease, while others survive and become capped resulting in a spotty or shotgun appearance of the capped stage of brood. Many other conditions and situations can cause a spotty brood pattern. For example, an inbred queen can produce a spotty brood pattern when the alleles at the sex locus become homozygous. This scenario produces fertilized, diploid males which are then consumed by worker bees. Although not unique to hives affected with EFB, a spotty brood pattern is a common symptom of EFB.

### EFB

- Can be slightly ropey with threads less than 1.5cm, but usually not ropey.
- Odor: Sour or none.
- Scale: Brown to black, rubbery.
- Stage of Brood: Before capped.
- Appearance: Twisted, dull to yellow to dark brown, tracheal tubes often visible.

### AFB

- Coffee color, ropey with a fine thread about 2.5 cm.
- Odor: Sulfurous, “chicken house.”
- Scale: Brown to black, brittle.
- Stage of Brood: After capped.
- Appearance: Chocolate brown to black, perforated cappings.

European foulbrood is considered to be more problematic in situations where forage nectar is sporadic, or other situations that result in fewer nurse bees in colonies to feed larvae. At the onset of nectar flow in early spring, forage recruitment of house bees may increase rapidly resulting in few bees in colonies to feed honeybee larvae. Often, when the nurse bee to larvae ratio stabilizes later in the season, or remains stable throughout a season, symptoms disappear. However, this disease can occur throughout a season and will sometimes not clear up on its own. In severe cases, colony death can occur. Also, yearly recurrence of EFB from contaminated combs and equipment can occur. The bacterium that causes EFB does not produce spores, but combs contaminated with the bacterium can still re-infect honeybees in subsequent years.

### **Causative agent**

European foulbrood is caused by the bacterium *Melissococcus plutonius* meaning “pertaining to Pluto or the underworld.” Additionally, several other bacteria that are only found in association with *M. plutonius* have been credited with causing EFB. These bacteria can overgrow *M. plutonius* and sometimes seem to improve its growth in lab conditions. These secondary, infective bacteria present with *M. plutonius* include *Paenibacillus alvei*, *Achromobacter (Bacterium) eurydice*, and *Bacillus laterosporus* Laubach. These bacteria are sometimes considered symbiotic and may cause some of the differences in smell and appearance in infected larvae. There is suspicion that some of these bacteria may have some causal relationship to symptom onset, but this link has never been clearly established.

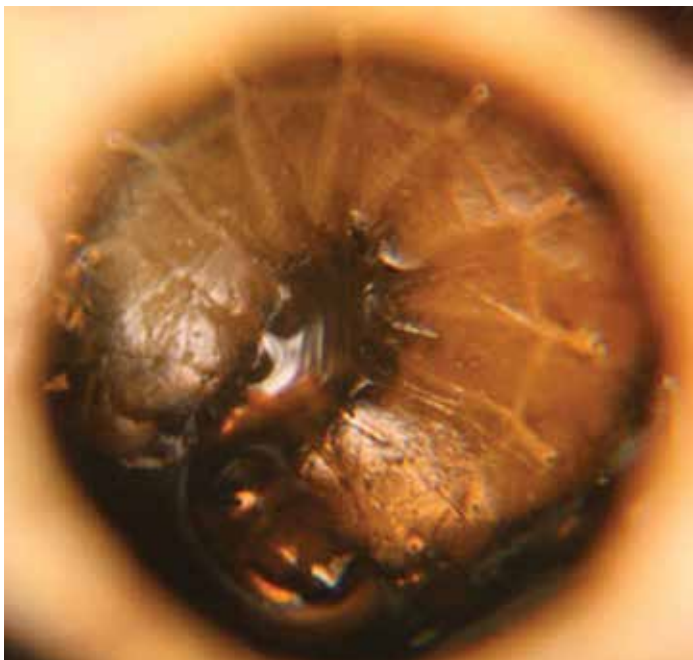

Figure 46: Larvae infected with *M. plutonius* can appear deflated with their tracheal system more defined.

### Life cycle of European foulbrood

Larvae become infected with European foulbrood when they consume brood food that contains the bacteria *M. plutonius*. There is also some evidence that transmission may occur from bites of the parasitic mite, *Varroa destructor*. Depending on the level of infection, and possibly the amount of available food, the infected larva will either survive or die.

Surviving larvae will become adults with generally lower weight and delayed pupation when compared to their uninfected counterparts. It is noted that an increased food supply from adequate numbers of nurse bees can reduce larval death and observed symptoms. This may explain why expression of the disease can change sporadically year to year, and season to season, depending on the balance of nurse bee to larvae ratio and thus, the amount of brood food made available to the larvae.



Figure 47: Pictured are off-colored to dull white larvae from a hive infected with European foulbrood. Note the somewhat pronounced tracheal tubes in the melted larvae to the right.

### Symptoms of European foulbrood

In hives infected with EFB, dying and dead larvae can become yellow and then brown. A sour, fishy odor may be present or not. Tracheal tubes can become more apparent as the larvae flattens or 'deflates' (Figure 46). The larvae can also twist as they die and can die curled upwards (Figure XX). Other times they melt in their cells and will generally be mushy. The remains can be slightly ropey with threads less than 1.5 cm long. To test if the remains are ropey, a toothpick, match or small stick can be probed into the cell and removed (Figure 48). Once dried, a rubbery scale remains. Test kits available from Vita can confirm diagnosis.



Figure 48: Probing a larva melted by European foulbrood. Note that the melted larva is usually not ropey.

### Control

There are limited options for possible cultural control of this disease. However, as noted above, treatment may not always be necessary in all cases if conditions change that result in disappearance of the disease. Control is sometimes necessary though. Requeening the colony may have some benefit, due to a break in the brood cycle, and supplying a queen that is more prolific. There is some evidence of genetic resistance towards the disease, but there are no known lines or breeds that are resistant to EFB, including lines bred for hygienic behavior. Hygienic lines are, however, clearly resistant to American foulbrood.

Due to the infectious activity of the bacteria on contaminated combs, moving combs and equipment should be expected to cause cross contamination. In some countries, destruction or sanitation of infected combs and equipment is required.

In the U.S., Terramycin is the only product labeled for the control of European foulbrood. Various concentrations are available. Users of this product



should pay particular attention to the product label to deliver the correct dose, or contact their local state beekeeping inspector or extension specialist for assistance.

## Seasonal Management

### Winter Season

#### December

- Repair and paint equipment.
- Clean supers, hive bodies, covers and frames of burr comb and propolis.
- Cull combs. Cull all combs with more than 2 square inches of drone cells from the frames, unless more drone production is desired.
- Do not disturb the cluster of bees. The hive can be lifted from the rear to estimate stores. On a warm, sunny day, the top can be removed to see the adult cluster size.

#### January

- Clean, paint and repair equipment.
- Check the apiary for wind and animal damage.
- On a warm, sunny day, check the honey stores and feed, with a candy board, any colonies that have less than 15 pounds (six frames of capped honey in a shallow super or two to three frames in a deep super). Note, this is an emergency feeding to prevent starvation and not recommended for colonies with adequate stores. **Do not** disturb the cluster of bees. The hive can be lifted from the rear to estimate stores. On a warm, sunny day, the top can be removed to see the adult cluster size.

#### February

- Open colonies on a warm day (if available) and check for laying queen, brood and diseases.
- Check amount of honey stores. The hive can be lifted from the rear to estimate stores. On cool, but not cold days, the top can be removed to see the adult cluster size.
- Feed all colonies with less than 15 pounds of honey with a candy board to prevent starvation.

Watch for incoming pollen on warm days. In February, brood rearing increases as the days become longer and pollen is produced by early flowering plants.

- Feed syrup and pollen substitute, if early, increased brood rearing is desired. Note: early, increased brood rearing increases risks of starvation in spring with sudden, prolonged cold snaps. During cold spells, the colony will cluster over the brood, keeping it warm. The colony will be unwilling to move to frames of stored honey. Also, feeding strong colonies in February will result in an early swarm season for your bees.
- Unite weak or queenless colonies with another colony (bees should cover five or more frames, but smaller colonies can often survive and build up in time to make some honey). Also, queens may not be apparently laying much at this time.
- Select the best of the two queens before uniting the two colonies. Remove one of the two queens before uniting. Use the newspaper method.
- February is the breeding season for skunks. They may be more active during this time. Skunks may scratch at hive entrances and eat the bees that come out to check.
- Order spring bees in this month or earlier if the supplier accepts earlier orders. Suppliers often sell out in March.

### Spring Season

#### March

- Check brood chambers. If all of the brood is in the upper part of the brood chamber, reverse the upper and lower brood chamber units. Do not split the brood by reversing when brood is present in both boxes. Reversing the chambers will cause the queen to use both units for egg laying. However, expanding the brood nest too early may cause chilled brood if cold weather reappears.
- Check the brood for diseases and mites each time you open the colony. Check the honey stores. Feed all colonies that have less than 15 pounds of honey stores to prevent starvation. Syrup, not candy boards, should be used at this time.
- Super colonies with drawn comb if available. It's a little early to super with foundation.

- March is a good time to find queens and mark them with paint and a clipped wing since the population of adult bees will be smaller at this time.

## **April**

- Super colonies for honey production with drawn comb or foundation early in April. Multiple boxes of drawn comb can be used, but only one foundation box at a time is needed.
- Strong colonies will consume large amounts of honey stores in April. If all reserves have been used up, the colonies will starve just prior to the honey flow if prolonged rainy weather sets in. Check stores and feed all colonies that have less than 15 pounds of honey, remove honey supers first. Feeding with honey supers on will contaminate your honey with syrup.
- Check brood chamber for diseases and mites.
- Install package bees in April. Package bees will do well when installed on all new foundation in the hive. When drawn comb and two frames of brood are available, packages get off to a better start.
- Add new foundation for drawing comb in upper hive body during a honey flow.
- Colonies with prolific queens and ample food will be strong in population and may need room. Add a super of drawn comb to relieve crowding.
- By April, you should have developed colony strength to 80,000 worker bees to produce a maximum honey crop.
- Check for the development of the swarming instinct. Raise the super just above the brood chamber and check for swarm cells along the bottom bars of the frames. If developing cells (not empty cups) are present, a swarm is imminent. Either split the hive to artificially swarm it, or watch for an issuing swarm in coming days. Recheck for swarm cells every seven to 14 days.
- April is a good month to divide colonies in advance of swarming instinct.
- Feed package bees 2 gallons of a 1:1 sugar syrup containing Fumidol-B. Package bees often suffer from nosema disease.
- Prepare supers with cut comb foundation just prior to using them.

- Remove entrance reducer from overwintered strong colonies by mid-April.

## **May**

- It is time to add another super when the honey super on a colony is one-half to two-thirds filled (six to seven frames). A few drawn frames can be moved up into an empty foundation super to encourage the bees to move up.
- Supers of cut comb honey foundation should be added on top of the honey super, which is on top of the brood chamber, to reduce the amount of pollen in the cut comb honey.
- Continue to check for swarm cells every seven to 14 days. Raise the super just above the brood chamber and check for swarm cells along the bottom bars of the frames. If developing cells (not empty cups) are present, a swarm is imminent. Either split the hive to artificially swarm it, or watch for an issuing swarm in coming days.
- Keep empty storage space in the supers on all colonies until the honey flow has ended.
- Remove and extract capped supers from your colonies if you need additional supers.

## **Summer Season**

### **June**

- Combine all swarms issuing after June 1 with weak colonies or feed them constantly until they are a full-sized hive.
- Continue to check for swarm cells every 14 days. Raise the super just above the brood chamber and check for swarm cells along the bottom bars of the frames. If developing cells (not empty cups) are present, a swarm is imminent. Either split the hive to artificially swarm it, or watch for an issuing swarm in coming days.
- Continue to add supers as needed until the honey flow ends.
- Remove the capped honey after June 15. Or after Aug. 15 if in sourwood honey producing areas (usually higher elevations).
- Uncapped honey should be checked for moisture content before extracting.

- Prepare and move your bees to the mountains or the second honey flow (sourwood areas) if you want maximum production.
- Extract the honey immediately to prevent destruction by small hive beetles.

## July

- If moving colonies to sourwood areas, have your bees in their new location before the first week of July.
- Extract any unremoved capped honey to have the supers available for the sourwood honey flow.
- Return extracted supers to the colonies just before dark to prevent robbing.
- Fumigate all supers of extracted combs that will be off the colonies for the remainder of the season with para-di-chloro-benzene. Wax moths can begin destroying them in a matter of days, depending on the situation.
- Pack honey in a quality, attractive package – all new, clean glassware or plastic ware and lids.
- Swarms issuing after mid-June will require constant feeding until they are a full-sized hive. They can be combined with weak colonies.
- Check for varroa mites.
- If your honey flow is over by this month, insert entrance reducers to prevent robbing and reduce the hive to the size of overwintering to help the colony manage hive beetles.
- Colonies will readily take feed and convert it to brood after the honey flow is over. Feed colonies where it is desired to build up their population (e.g. new colonies started late).

## August

- Extract remaining supers.
- Return extracted supers to colony for cleaning just before dark to prevent robbing by colonies.
- Remove cleaned supers from colony, and store under para-di-chloro-benzene fumigation to prevent wax moth damage.
- Check brood nest for diseases and mites. Mite populations tend to peak late in August or early

September and can cause death or irreversible damage in this month.

- Treat for varroa mites if necessary. Remove honey for human consumption first. If treating annually, treat in August to control mites in advance of the production of overwintering bees and peak in mite numbers.
- Requeen if desired before or after treating for mites, but not during. Many mite treatments affect queen laying.
- Before placing new caged queen in the colony, remove the old queen. Check the brood chamber and make sure you have adequate brood and adult bee population for survival (e.g. two or more frames of sealed brood). Place the caged queen over the frames of brood, 24 hours later.
- Recheck the requeened colonies in three days for release from the cage and at 10 days for a laying queen. If eggs are present, do not disturb the colony.
- Insert entrance reducers to prevent robbing and reduce the hive to the size of overwintering to help the colony manage hive beetles, if not already done.
- Colonies will readily take feed and convert it to brood after the honey flow is over. Feed colonies where it is desired to build their population (e.g. weak colonies and new colonies started late).

## Fall Season

### September

- Check colony for varroa. If numerous (see Sensitivity of Method), apply treatment, if not already treated in August.
- Requeen colonies that you did not requeen in August or that rejected the introduced queen in August if desired
- Colonies will begin to arrange their brood nest for overwintering. Do not mix up frames by moving them around unnecessarily.
- Replace all hive parts that need repairing or painting with reconditioned parts. Repair and painting can be done much more easily in the shop.

- Feeding in September can stimulate additional foraging, honey storage, and brood rearing for colonies that need the extra help.
- Colonies will need at least 40 pounds of stored honey for overwintering by the first frost.
- If feeding Fumadil-B to reduce nosema spore load, do this in late September or early October when colonies are more likely to accept feed.

## October

- October is usually too late to treat for mites. The recommended products will not work as well in cool temperatures and varroa reproduction has already peaked and caused damage if levels were high.
- Check each colony for a laying queen.
- Feed all colonies that do not have at least 40 pounds of honey stored. (A deep-brood frame holds 6 to 7 pounds of honey; a medium frame holds 4 1/2 pounds; a shallow super frame holds 3 1/2 pounds.)
- Feed a mixture of 2 parts of sugar to 1 part water (measured by weight) to make a heavier feed, however 1:1 is acceptable and can be mixed without heating.
- Colonies typically slow down or stop taking syrup feed after the first hard frost.
- If feeding Fumadil-B to reduce nosema spore load, do so by early October when colonies are more likely to accept feed.
- Rake all leaves and dead grass away from around colonies to prevent fire in at risk areas. The Tennessee fall fire season usually begins in mid-October.

## November

- Cut tall grass to reduce moisture against hives and reduce wood rot.
- Check all tops to be sure they are waterproof.
- Place a weight on the outer cover to prevent the wind from blowing the top off the hive.
- Feed all colonies that do not have at least 40 pounds of honey stored. (A deep-brood frame

holds 6 to 7 pounds of honey; a medium frame holds 4 1/2 pounds; a shallow super frame holds 3 1/2 pounds.)

- Feed 2:1 syrup or prepare a candy board for feeding colonies without enough stored honey for overwinter. Colonies may not take syrup after the first hard frost and tend to not be able to convert syrup to stored honey. Alternatively to a candy board, sugar 'goop' may be used. To make sugar goop, a spacer can be placed above the top box. Lay a single layer of newspaper down. Trowl out a mixture of granulated sugar and water. The mixture is made with a very small amount of water so that the sugar granules stick together and do not run.

## Disclaimer

This publication contains pesticide recommendations that are subject to change at any time. The recommendations in this publication are provided only as a guide. It is always the pesticide applicator's responsibility, by law, to read and follow all current label directions for the specific pesticide being used. The label always takes precedence over the recommendations found in this publication.

Use of trade or brand names in this publication is for clarity and information; it does not imply approval of the product to the exclusion of others that may be of similar, suitable composition, nor does it guarantee or warrant the standard of the product. The author(s), the University of Tennessee Institute of Agriculture and University of Tennessee Extension assume no liability resulting from the use of these recommendations.









E12-4612-00-001-17 PB 1745 (REV) 2/17 6M 17-0102

Programs in agriculture and natural resources, 4-H youth development, family and consumer sciences, and resource development. University of Tennessee Institute of Agriculture, U.S. Department of Agriculture and county governments cooperating. UT Extension provides equal opportunities in programs and employment.